



DE Aufbauanleitung „HochBeet“ und „Belvedere®“

- Ⓒ GB Assembly manual for "Raised Vegetable Bed" and "Belvedere®"
- Ⓒ FR Notice de montage du "Potager surélevé" et "Belvedere®"
- Ⓒ NL Opbouwbeschrijving voor "MoestuinBox" en "Belvedere®"
- Ⓒ ES Instrucciones de montaje de "Huerto Urbano" y "Belvedere®"
- Ⓒ IT Istruzioni di montaggio "Aiuola rialzata" e "Belvedere®"
- Ⓒ DK Monteringsvejledning for "Højbed" og "Belvedere®"



 Poišćite vař prevod na ...

 Najděte svůj překlad ...

 Hitta din översättning ...

 Finn din oversettelse ...

 Találja meg fordítását ...



Wichtige Punkte für den Aufbau!

Vorliegende Aufbauanleitung zeigt den Zusammenbau für ein „Hochbeet“ Größe „2x1“; sie gilt sinngemäß auch für die Größen „1x0,5“ , „2x0,5“ , „1x1“ , „2x2“ und „L“. Für einige Montageschritte benötigen Sie einen Helfer.

- GB *Important details regarding assembly! This assembly manual shows the erection of the "Raised Vegetable Bed" size "2x1"; it is also valid for size "1x0,5" , "2x0,5" , "1x1" , "2x2" and "L". For several assembly steps additional assistance of one person will be required.*
- FR *Points importants lors du montage! „Cette notice de montage décrit l'assemblage du „portager surélevé“ taille «2x1»; celle-ci est aussi valable pour la taille «1x0,5» , «2x0,5» , «1x1», «2x2» et «L». Pour certaines étapes, demandez l'aide d'une ou deux personnes.*
- NL *Deze opbouwbeschrijving beschrijft de opbouw van een MoestuinBox grootte 2x1. Deze geldt ook voor de grootte 1x0,5 , 2x0,5 , 1x1 , 2x1 en L. Bij enkele stappen tijdens de opbouw heeft u een 2e persoon nodig.*
- ES *Notas importantes para el montaje: Estas instrucciones muestran el montaje del „Huerto Urbano“ en tamaño „2x1“. También son válidas para los tamaños „1x0,5“ , „2x0,5“ , „1x1“ , „2x2“ y „L“. Es recomendable realizar el montaje entre dos personas.*
- IT *Indicazioni importanti per il montaggio! Le istruzioni qui descritte sono riferite all' „Aiuola rialzata“ Misura „2x1“; per analogia valgono anche per le misure „1x0,5“ , „2x0,5“ , „1x1“ , „2x2“ e „L“. Per alcune fasi di assemblaggio vi servirà qualche aiutante.*
- DK *Vigtige punkter ved samling! Samlemanualen viser opsætningen af "Højbed" str. "2x1"; gælder også for størrelse "1x0,5" , "2x0,5" , "1x1" , "2x2" og "L". Ved flere punkter af opsætningen er yderligere hjælp påkrævet af 1 eller 2 personer.*



Um Kratzer zu vermeiden, verwenden Sie bitte geeignete Unterlagen!

- GB *Please use a suitable underlay to avoid scratches!*
- FR *Pour éviter les rayures, utilisez les supports appropriés!*
- NL *Om krassen te voorkomen raden wij u aan er iets onder te leggen!*
- ES *Por favor, coloque en el suelo una base protectora adecuada para evitar posibles arañazos.*
- IT *Utilizzare una base adatta per evitare graffi!*
- DK *Benyt venligst et passende underlag for at undgå skrammer!*



Optionales Zubehör - Symbol:

Arbeitsschritte die blau eingerahmt sind, zeigen den Einbau eines optionalen Zubehörteiles.

- GB *Symbol of optional accessories: Blue framed assembly steps show the installation of optional accessories.*
- FR *Accessoires en option-Symbole: La trame entourée en bleu indique une étape avec accessoires en option. A réaliser uniquement si vous avez commandé cet accessoire.*
- NL *Extra Toebehoor: Montageschappen met een blauwe rand betreffen de inbouw van extra toebehoor.*
- ES *Accesorio opcional - símbolo: Los pasos de montaje que se encuentran enmarcados en azul muestran el montaje de una pieza de un accesorio opcional.*
- IT *Simbolo per accessori opzionali: Le fasi del montaggio incorniciate in colore azzurro mostrano l'installazione di un accessorio opzionale.*
- DK *Symbol for ekstra udstyr: Blåt indrammet samletrin viser installationen af ekstraudstyr*



optionales Zubehör

Zwischenboden

Intermediate floor - Intermédiaire



Größenabhängiger Montageschritt!

- GB *Size-Dependent assembly step!*
- FR *Dépendant de la taille assemblage étape!*
- NL *Size-Dependent montageschritt!*
- ES *Paso de montaje de tamaño Dependiente!*
- IT *Taglia-Dependent fase di montaggio!*
- DK *Størrelses-afhængig montage skridt*



Größenabhängiger Montageschritt

Nur für Größe L

Only for size L - Uniquement pour taille L



Wasserwaagen - Symbol:

Betreffendes Einbauteil mit der Wasserwaage ausrichten.

- GB *Symbol of spirit level: Align the respective parts by using the spirit level.*
- FR *Symbole niveau à bulle: Lorsque ce symbole apparaît, vous devez ajuster l'élément à l'aide d'un niveau à bulle.*
- NL *Waterpas - symbol: Bij montageschappen waar dit symbool bijstaat is het noodzakelijk het betreffende onderdeel waterpas in te bouwen.*
- ES *Símbolo del nivelador: Indica que se debe ajustar y centrar la pieza con la ayuda de un nivelador.*
- IT *Simbolo di livella a bolla d'aria: Allineare il componente in questione con l'ausilio di una livella a bolla d'aria.*
- DK *Symbol for vaterpas: Juster de respektive dele ved hjælp af vaterpas.*

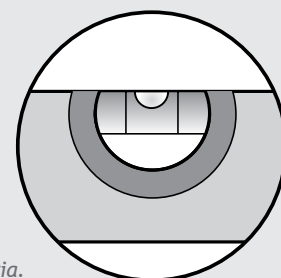



Verwenden Sie bei der Montage Arbeitshandschuhe!

(GB) Wear working gloves!

(ES) Utilice unos guantes de trabajo.

(FR) Portez des gants de travail

(IT) Utilizzare guanti da lavoro

(NL) Handschoenen gebruiken!

(DK) Brug arbejdshandsker!



Maßstabsgetreue Abbildungen der zu verwendenden Schrauben:

(GB) Scale drawing 1:1 of the screws in use

(FR) Reproduction selon l'échelle 1:1.

(NL) Afbeelding : schaal 1:1 (ware grootte)

(ES) Reproducción a escala 1:1 de los tornillos que se utilizan para el montaje.

(IT) Riproduzione in scala 1:1 delle viti da utilizzare.

(DK) Skala tegning af skruer er 1:1

M 1:1



4,8 x 19

Pflege und Wartung

- Keine aggressiven Chemikalien wie z.B. Chlor oder Streusalz lagern!
- Sonnenmilch und andere Cremes mit Wasser und Seife entfernen
- Keine scheuernden Reinigungsmittel verwenden!

(GB) Care and maintenance

- Do not store aggressive substances i.e. chlorine or road salt
- Remove suntan lotion or any other creams with water and soap!
- Do not use abrasive cleaning agents!

(FR) Entretien et maintenance

- Ne pas stocker de produits chimiques (chlore, sel, etc...)
- Nettoyez les traces de crème solaire ou autre uniquement avec de l'eau et du savon
- Ne pas utiliser de produits nettoyant abrasifs!

(NL) Onderhoud

- Geen chemicaliën in de Moestuinbox!
- Zonnebrandolie/melk en andere cremes met water en zeep verwijderen!
- Gebruik geen schuurmiddelen!

(ES) Cuidado y mantenimiento

- No almacene productos químicos agresivos dentro del Huerto Urbano, como por ejemplo cloro y sal antiescarcha.
- Evite dejar huellas o restos de cremas solares sobre la chapa. Limpie al arcón siempre con agua o un trapo húmedo.
- No utilice ningún producto para fregar. En general, evite siempre cualquier producto químico para limpiar al arcón.

(IT) Manutenzione

- Non lasciare prodotti chimici aggressivi (come ad esempio cloro o sale per strade) all'interno della Aiuola rialzata!
- Rimuovere crema solare e altre creme con acqua e brillantante!
- Non utilizzare detergenti contenenti sostanze aggressive!

(DK) Pleje og vedligeholdelse

- Opbevar ikke aggressive stoffer dvs. Klor eller vejsalt!
- Fjern solcreme eller andre typer af creme med vand og rensmiddel!
- Brug ikke aggressive rengøringsmidler!

Teileübersicht

parts list · liste des pièces · stuklijst · lista de piezas · lista de parti · deloversigt

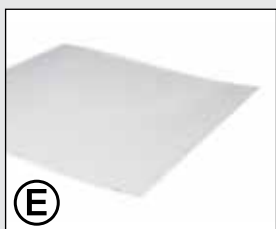
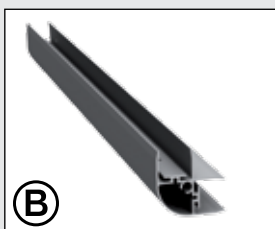
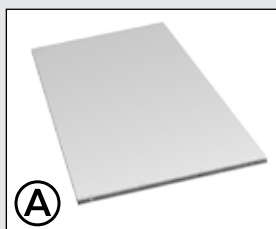

1.

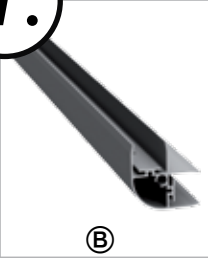

1x0,5: 4x
2x0,5: 4x
1x1: 4x
2x1: 4x
2x2: 4x
L: 6x



1x0,5: 4x
2x0,5: 4x
1x1: 4x
2x1: 4x
2x2: 4x
L: 6x



2.



1x0,5:	1X (940mm)	1X (450mm)
2x0,5:	1X (1930mm)	1X (450mm)
1x1:	2X (940mm)	
2x1:	1X (1930mm)	1X (940mm)
2x2:	2X (1930mm)	
L:	1X (1930mm)	1X (940mm)

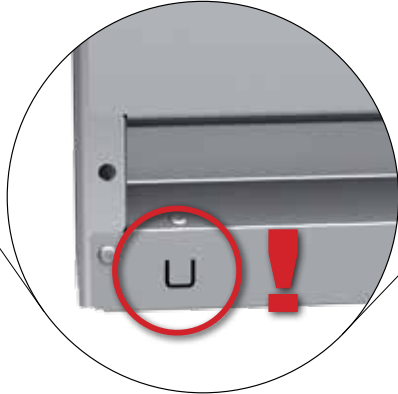
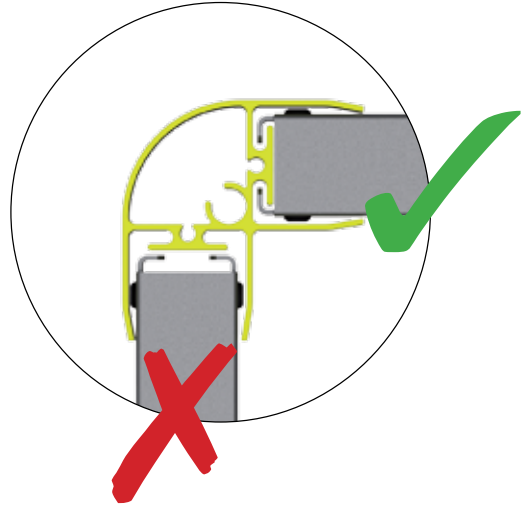

3.

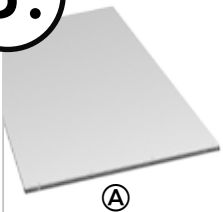

1x0,5:	1X (940mm)
2x0,5:	1X (1930mm)
1x1:	1X (940mm)
2x1:	1X (1930mm)
2x2:	1X (1930mm)
L:	1X (940mm)

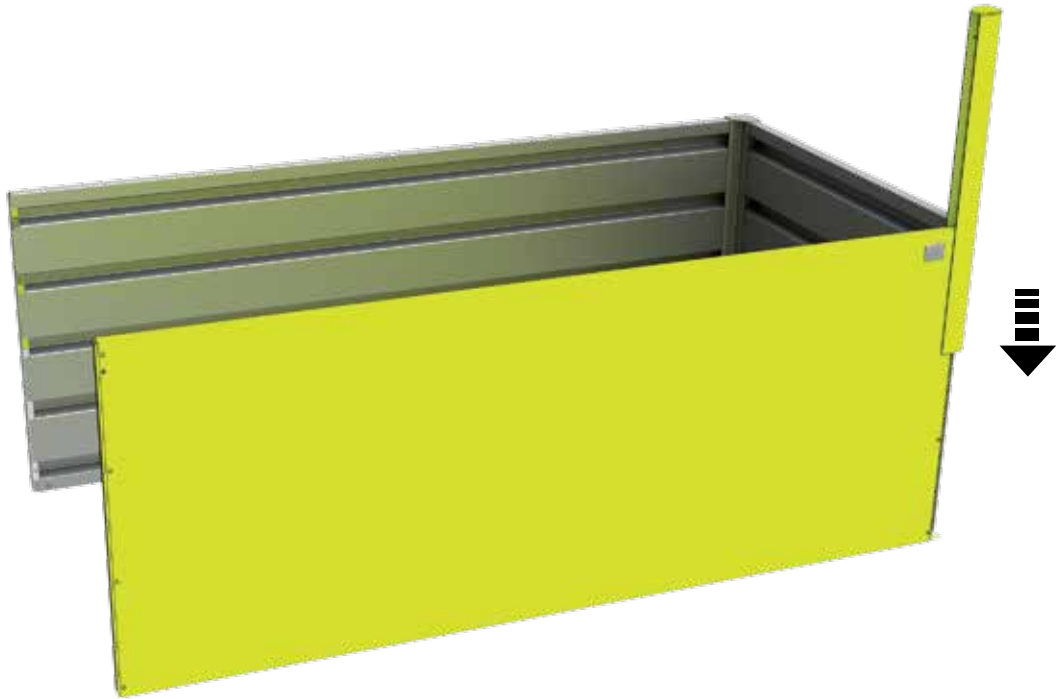

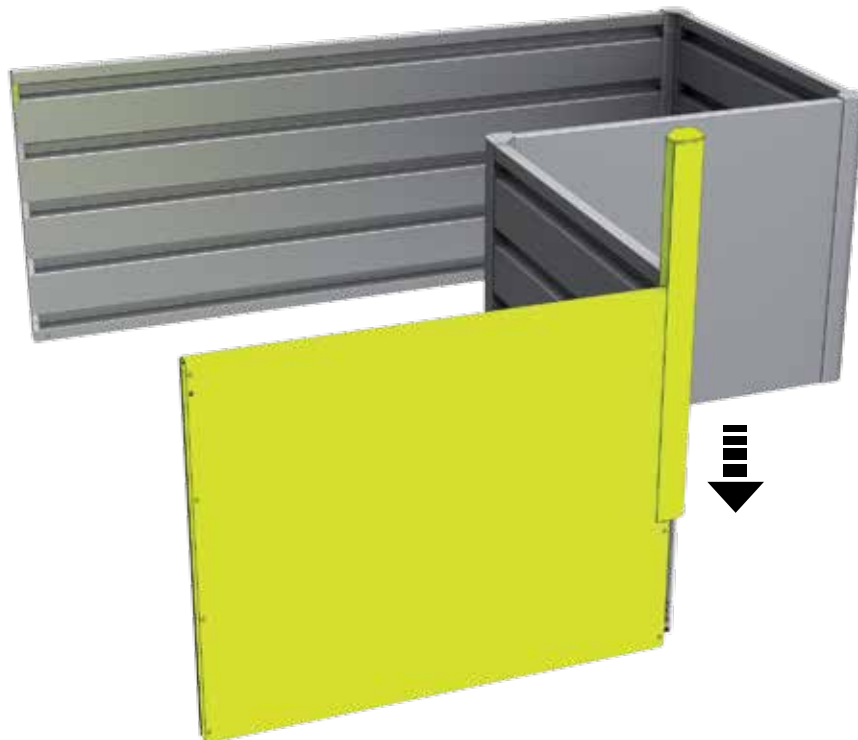
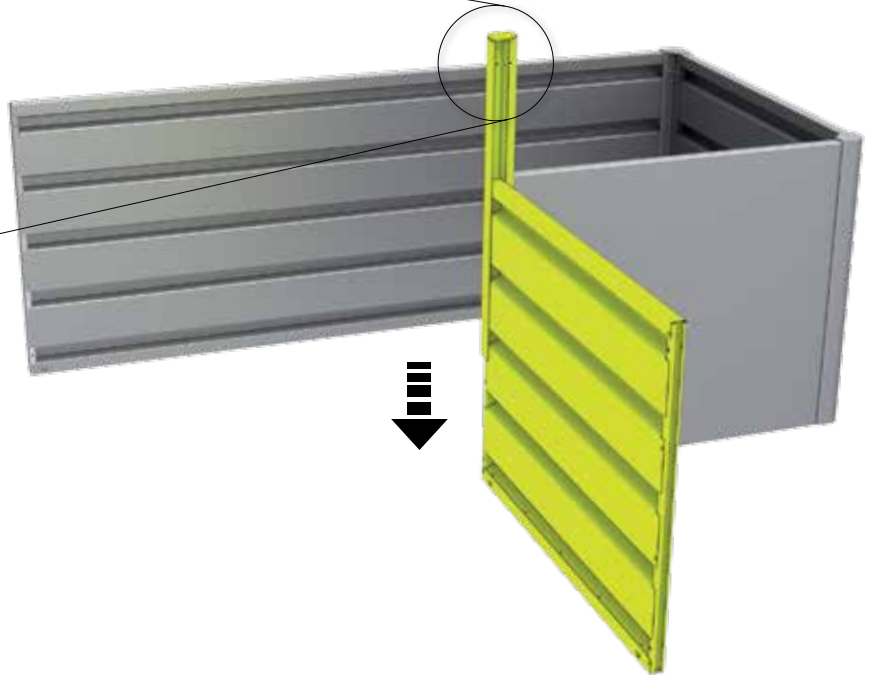
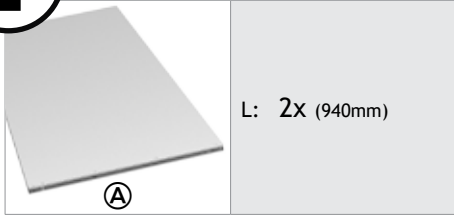



Ab diesem Punkt die Zwischenboden Aufbauanleitung verwenden

Muss nur ausgeführt werden, wenn Sie das Zubehör auch bestellt haben.

- Ⓒ From this point on, please follow the assembly manual for intermediate floor. Only if you have ordered this accessory.
- Ⓕ A partir de cette étape, veuillez utiliser les instructions de montage du sol intermédiaire. A utiliser uniquement si vous avez commandé cet ccessoire.

5.

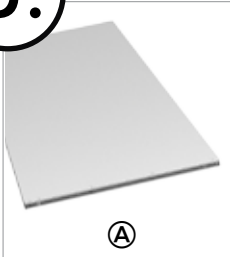

1x0,5:	1X (450mm)
2x0,5:	1X (450mm)
1x1:	1X (940mm)
2x1:	1X (940mm)
2x2:	1X (1930mm)
L:	1X (1930mm)



6.

4,8 x 19



D1

- 1x0,5: 8x
- 2x0,5: 8x
- 1x1: 8x
- 2x1: 8x
- 2x2: 8x
- L: 12x

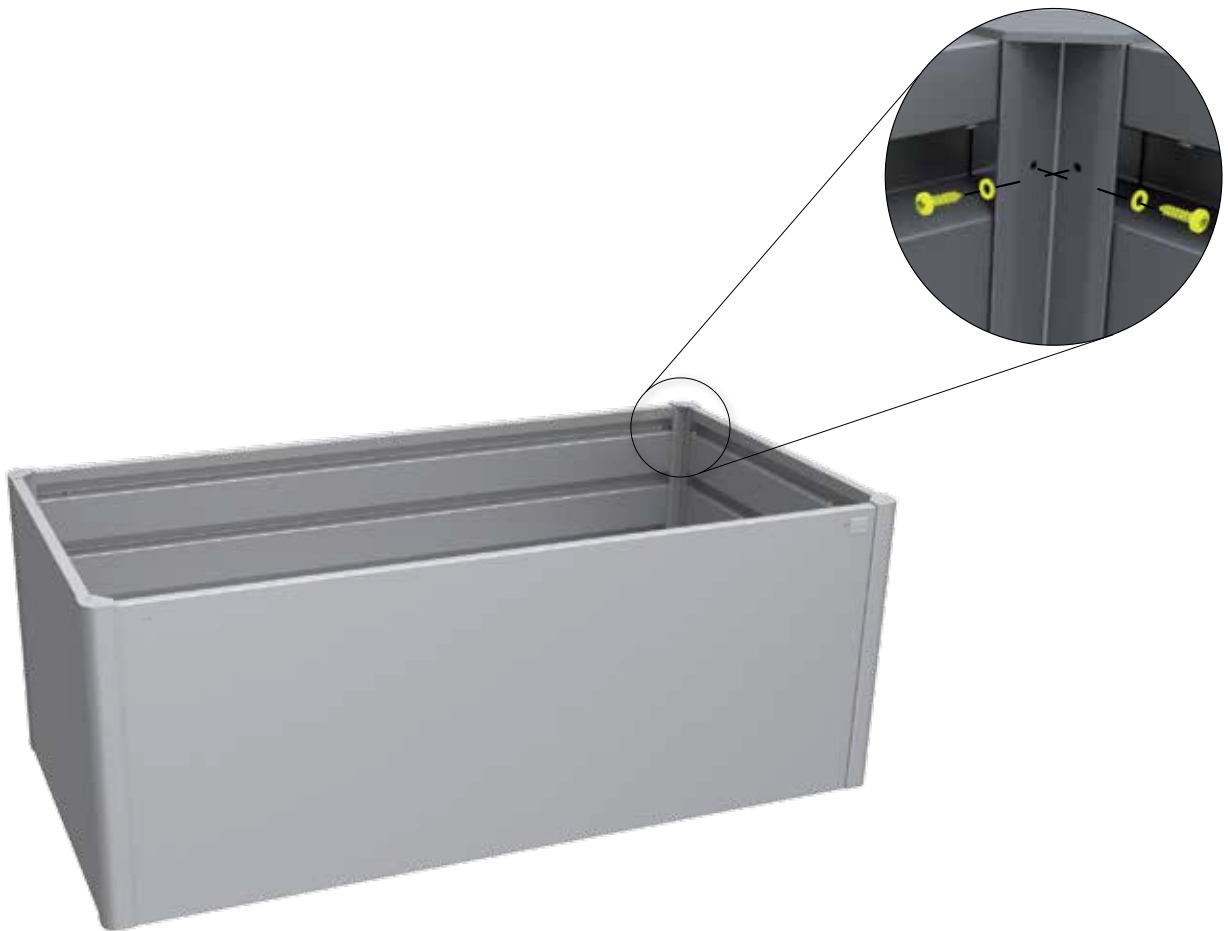

7.

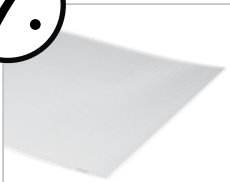
	1x1: 1x
	2x1: 1x
	2x2: 2x
	L: 2x



Größenabhängiger Montageschritt - Size-Dependent assembly step - Dépendant de la taille - Size-Dependent montagestep

Nur für Größe 1x0,5 und 2x0,5

Only for size 1x0,5 and 2x0,5 - Uniquement pour taille 1x0,5 et 2x0,5 - Alleen voor maat 1x0,5 en 2x0,5 - Sólo para los tamaños 1x0,5 y 2x0,5 - Solo per misura 1x0,5 e 2x0,5 - Kun for størrelse 1x0,5 og 2x0,5

1.

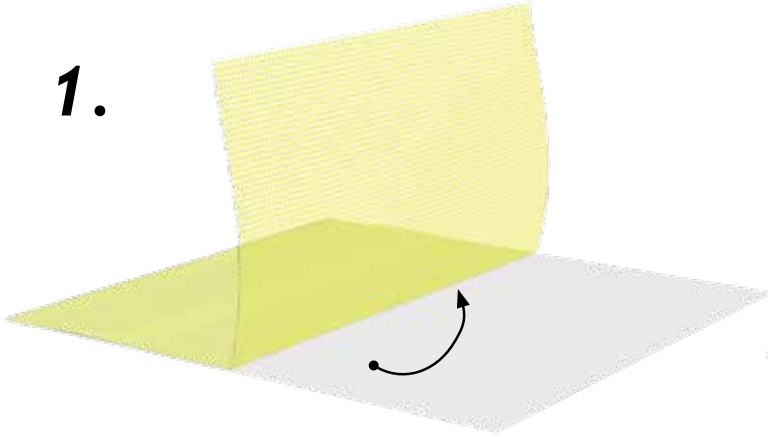

2.



Paso de montaje de tamaño Dependiente - Taglia-Dependent fase di montaggio - Størrelses-anhængig montage skridt

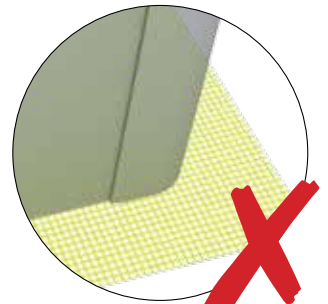
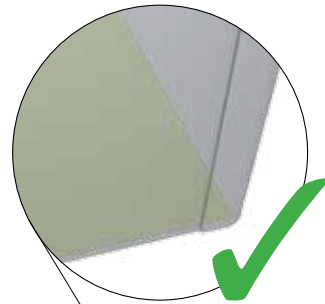

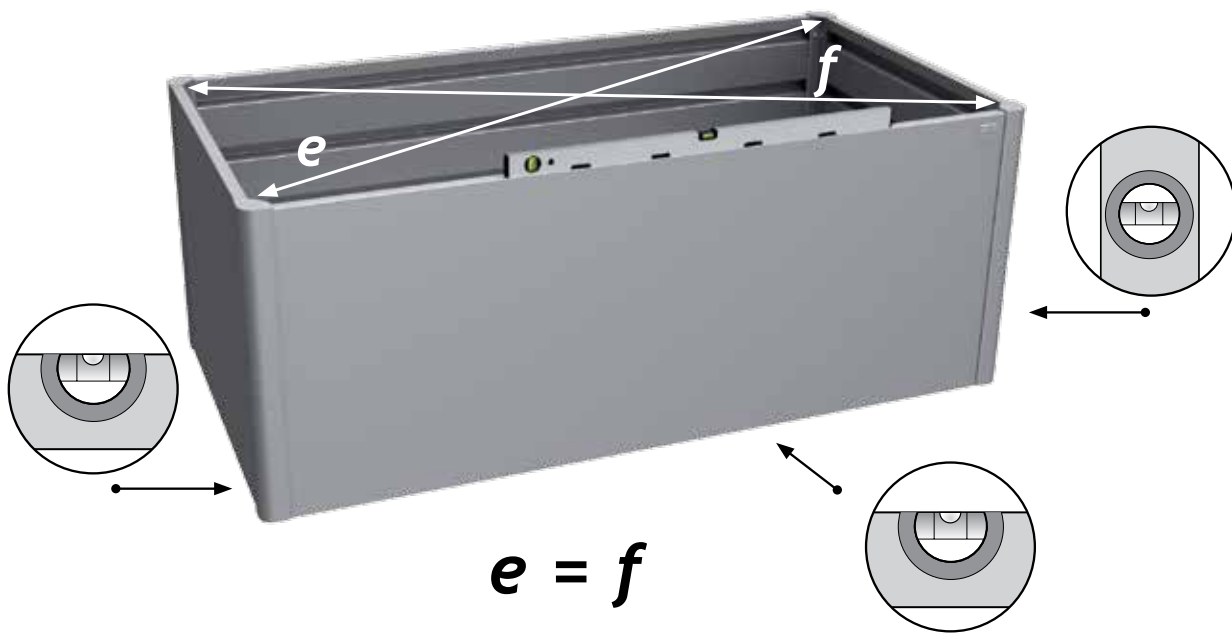

GARTENERDE

— Garden soil - Terreau - Tuinaarde - Sustrato para jardín - Terriccio - Havejord

KOMPOST UND LAUB

— Compost and foliage - Compost et feuille - Compost en bladafval - Compost y hojas - Terriccio e foglieame - Kompost og blade

FEIN GEHÄCKSELTES ODER GRAS

— Rough mulch or grass - Fine copeaux de bois et herbe - Houtspaanders of gras - Madera muy picada o hierba - Pacciame di cortecchia oppure erba - Fint hakket eller græs

ÄSTE ODER ZWEIGE

— Branches or twigs - Branche et brindille - Takken - Ramas - Rami - Grene eller kviste



Gerätehäuser

Setzen Sie auf
Qualität & Langlebigkeit



Gartenboxen

Outdoorboxen für
Garten, Terrasse & Co



Fahrrad-Garagen

Fahrräder, Roller & Co sicher
verstaut



Mülltonnen-Boxen

Stylisch, praktisch
und wartungsfrei



Brennholzlager

Kaminholzlager und Geräte-
schrank in einem



Pflanzgefäße und Garten-Helfer

Gartendesign
in Bestform

Kontrollnummer:
Control-number / Contrôle-Qualité / Controlnummer:



Bei Reklamationen bitte anführen:
Kontrollnummer und Artikelnummer des reklamierten Teils.

GB: In case of complaint please indicate the control-number and the number of the item, which is subject of complaint.

F: Pour toutes réclamations: prière de joindre le numéro de contrôle et le numéro d'article de la pièce litigieuse.

NL: Bij reclamaties svp doorgeven: controlnummer en artikelnummer van het desbetreffende onderdeel.