

C-01

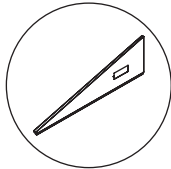

21L x 2

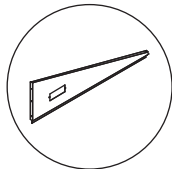

21R x 2

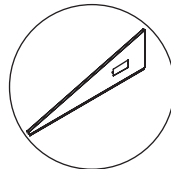

27L x 2

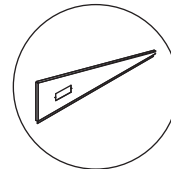

27R x 2

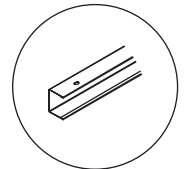

C1 x 2

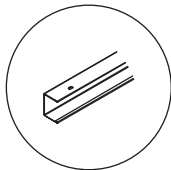

C2 x 2

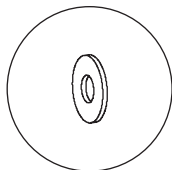

S3 x 16

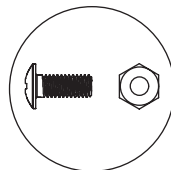

F2 x 24

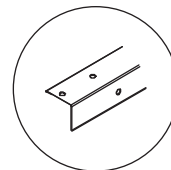

B1 x 2

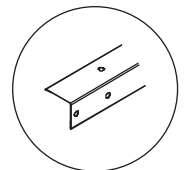

B2 x 2

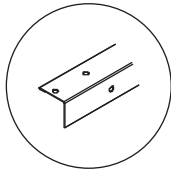

B3 x 2

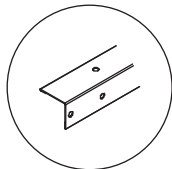

B4 x 2

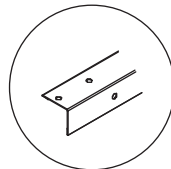

B5 x 2

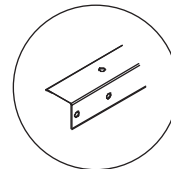

B6 x 2

1

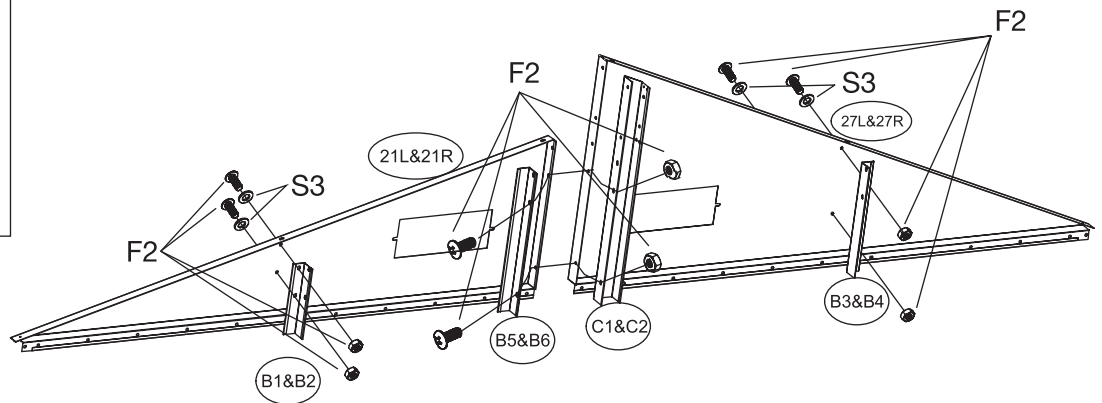
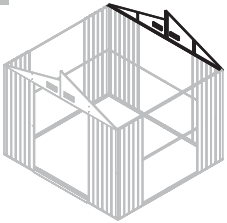

2

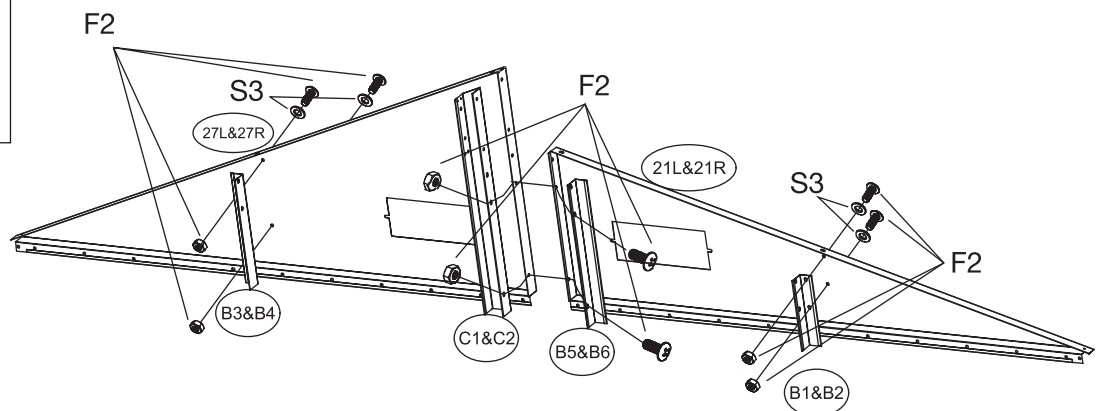
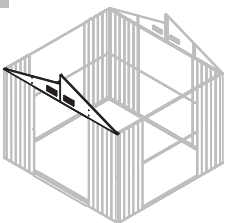

C-02

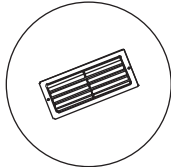

GF x 4

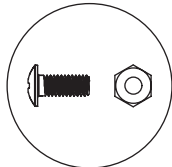

F2 x 8

x2

1

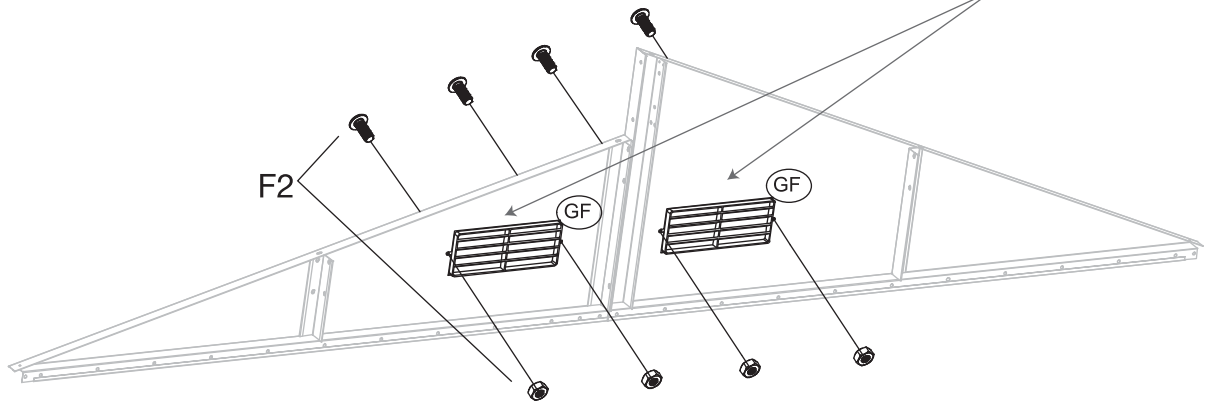
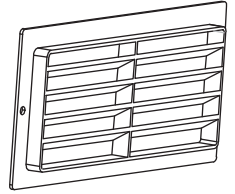

C-03

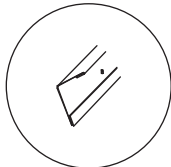

10L x 1

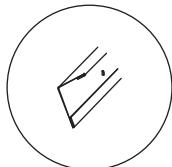

10R x 1

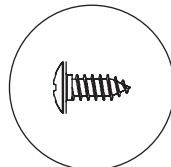

F1 x 1

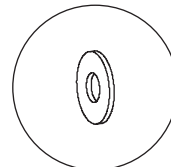

S3 x 13

1

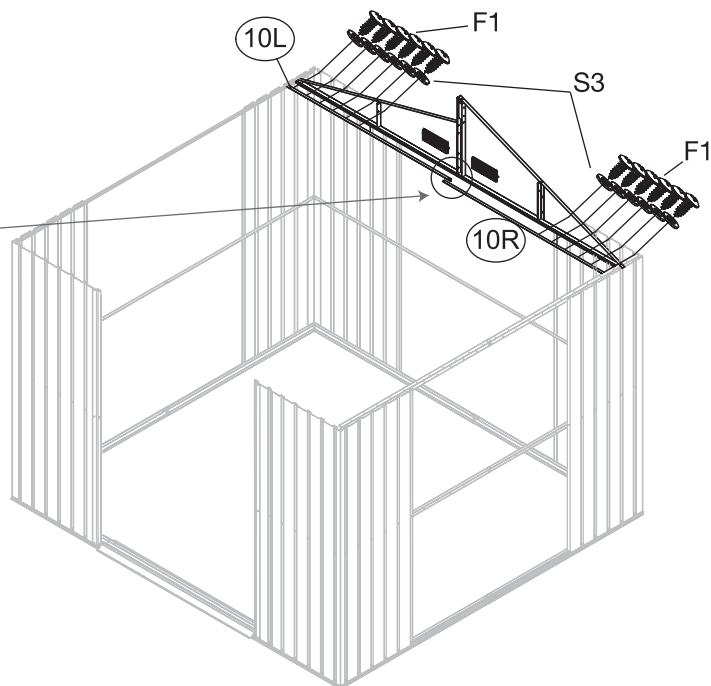
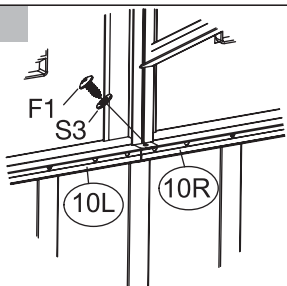

# C-04

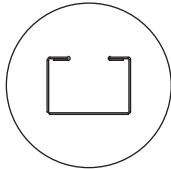

7 x 1

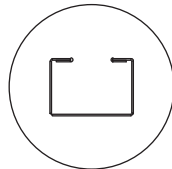

8 x 1

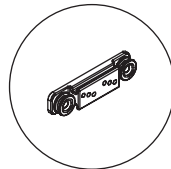

G2 x 4

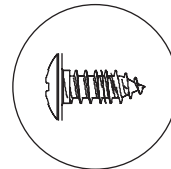

F1 x 12

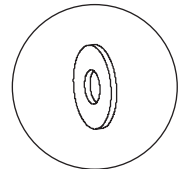

S3 x 12

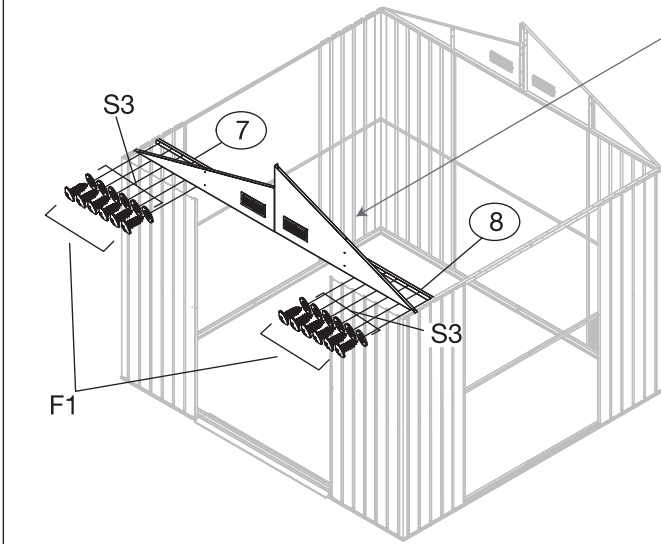
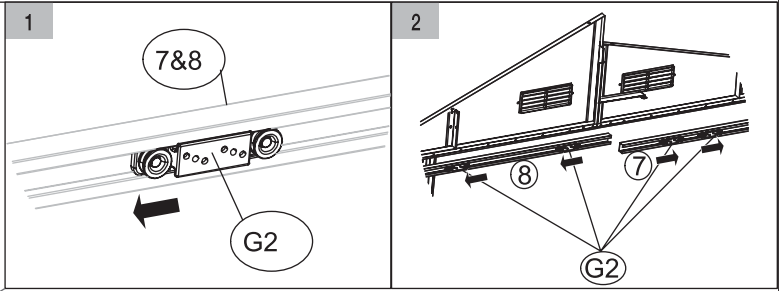

# C-05

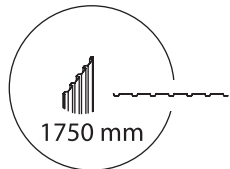

1750 mm

P3 x 6

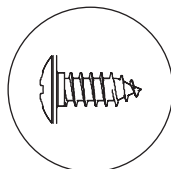

F1 x 117

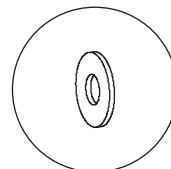

S3 x 117

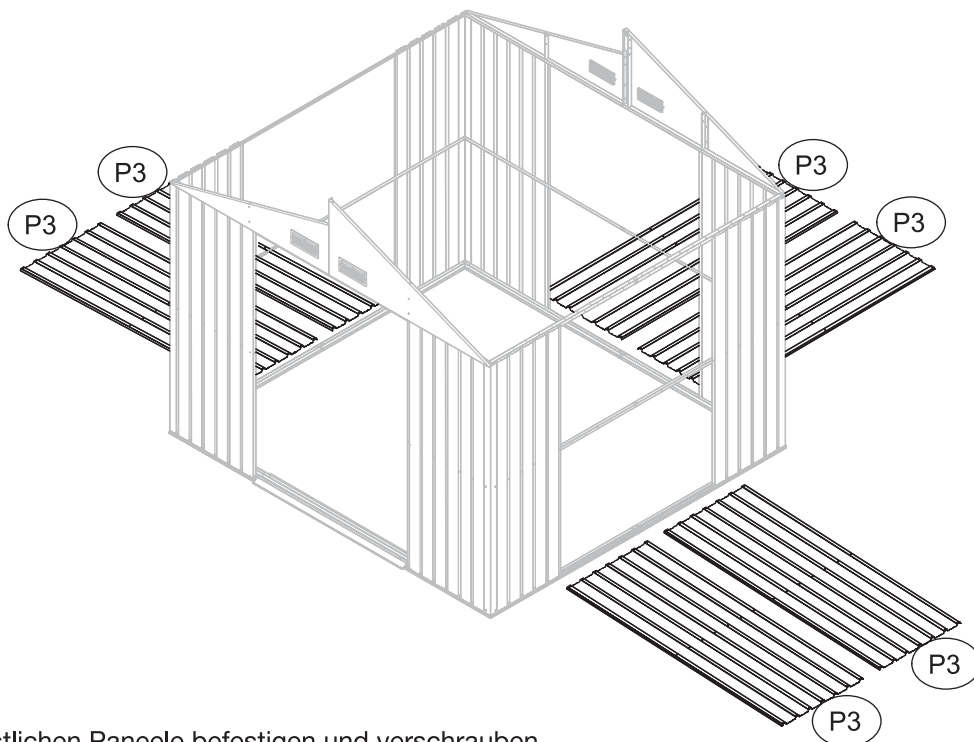

Die restlichen Paneele befestigen und verschrauben.

C-06

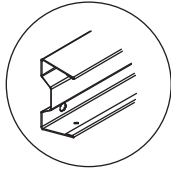

13 x 1

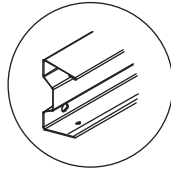

14 x 1

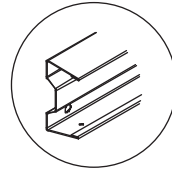

13\_1 x 1

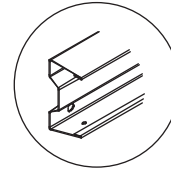

14\_1 x 1

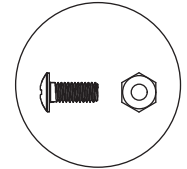

F2 x 8

1

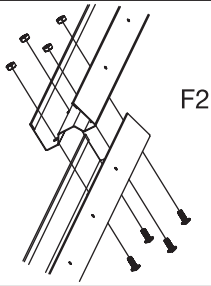

F2

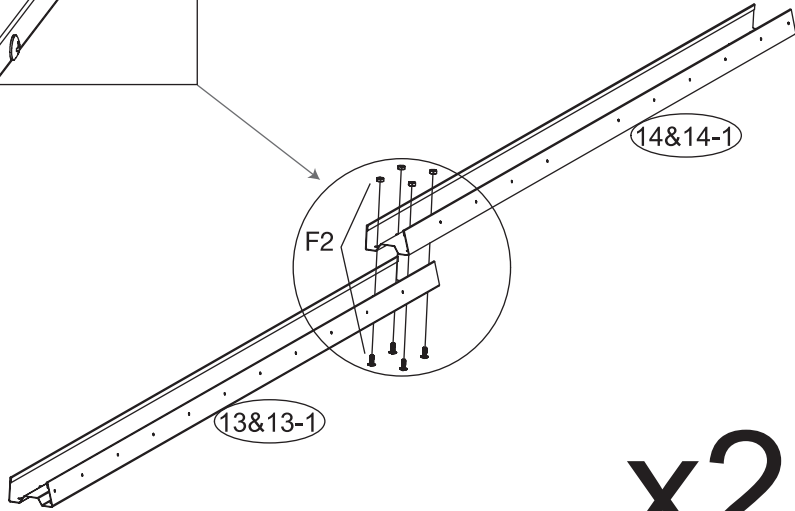
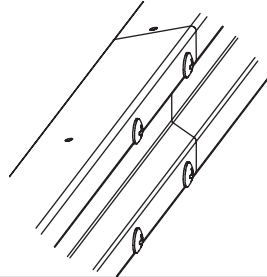

x2

C-07

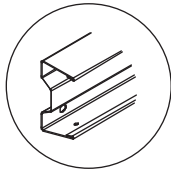

13 x 1

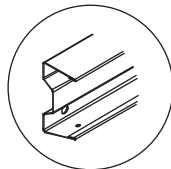

14 x 1

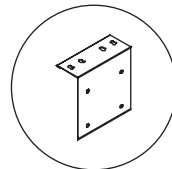

C9 x 1

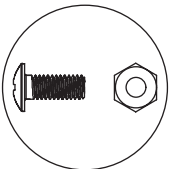

F2 x 4

1

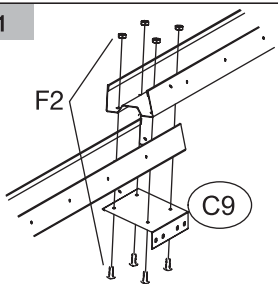

F2

C9

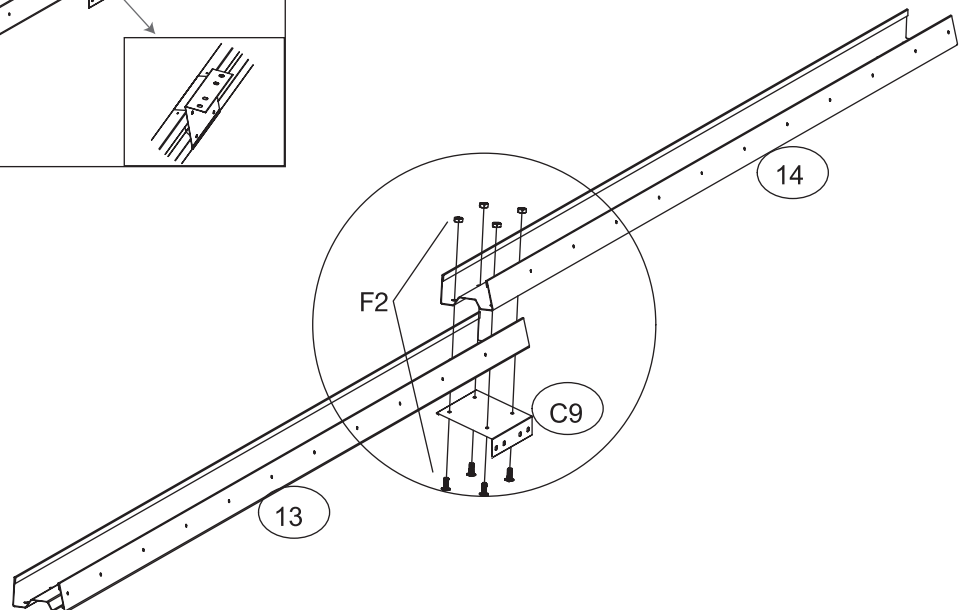
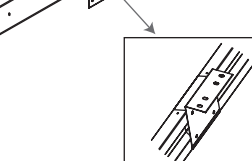
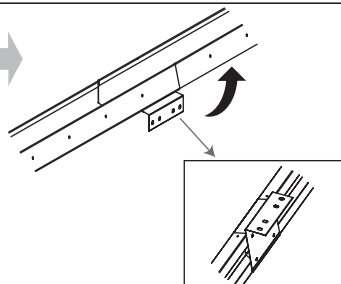

C-08

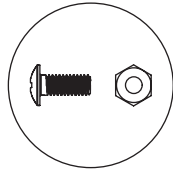

F2 x 12

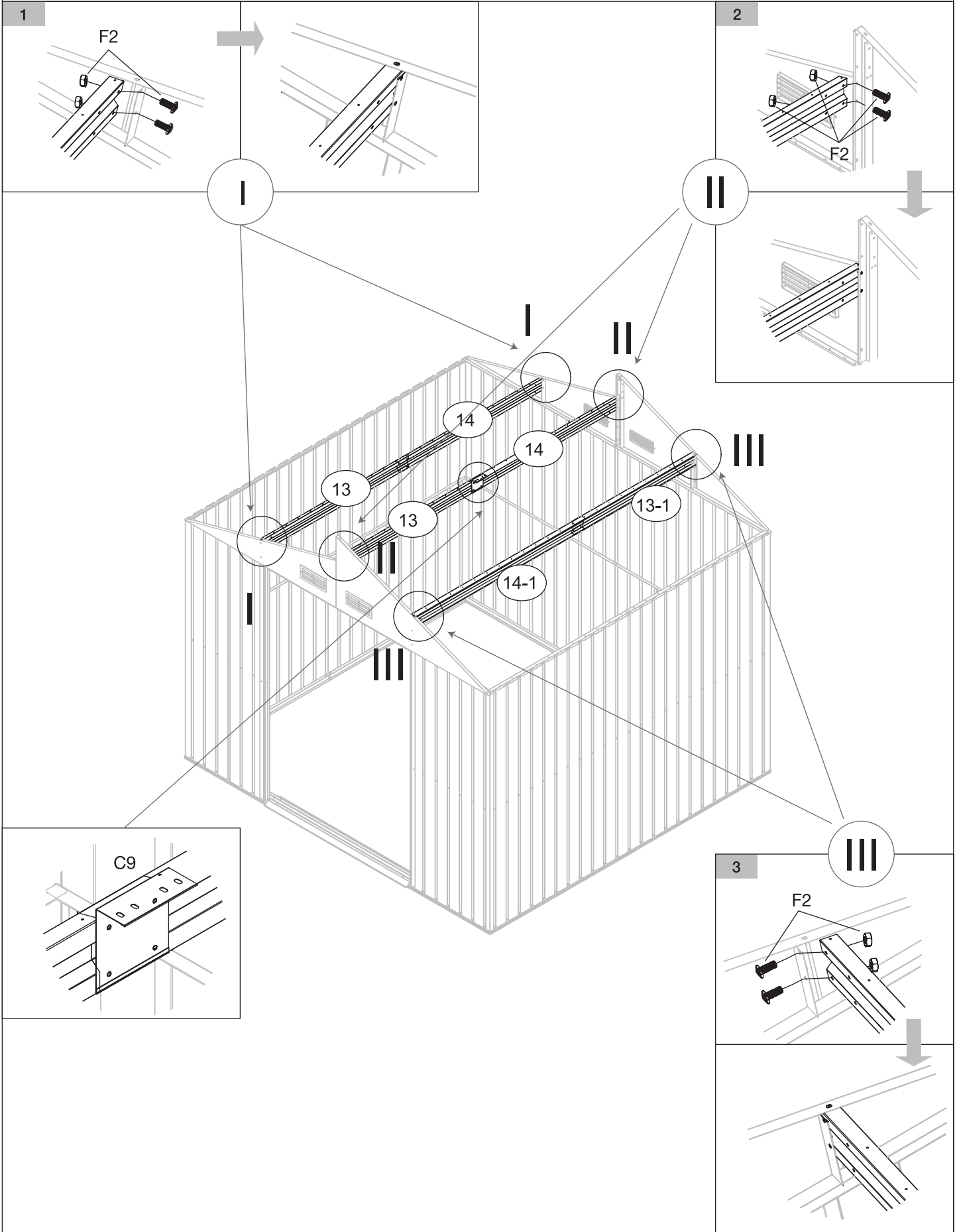

C-09

