



DE Aufbauanleitung Terrassenschrank „Romeo“

- Ⓜ GB Assembly manual patio locker „Romeo“
- Ⓜ FR Notice de montage armoire de terrasse Roméo
- Ⓜ NL Opbouwbeschrijving terras kast „Romeo“
- Ⓜ ES Instrucciones de Montaje Armario para la terraza Romeo
- Ⓜ IT Istruzioni di montaggio armadio da terrazzo “Romeo”
- Ⓜ DK Montagevejledning Terrasseskab “Romeo”



 Poišćite vař prevod na ...

 Najděte svůj překlad ...

 Hitta din översättning ...

 Finn din oversettelse ...

 Találja meg fordítását ...

! Wichtige Punkte für den Aufbau!

Vorliegende Aufbauanleitung zeigt den Zusammenbau vom Terrassenschrank Romeo Größe „M“, sie gilt sinngemäß auch für die Größe „L“. Für einige Montageschritte benötigen Sie 1 bis 2 Helfer.

- (GB) *Important details regarding assembly! The present assembly manual shows the assembly of the patio locker Romeo in size "M" but works for size "L" likewise. For several assembly steps additional assistance of 1 or 2 people will be required.*
- (FR) *Points importants lors du montage! " Cette notice de montage décrit l'assemblage de l'armoire de terrasse Romeo taille M, elle s'applique également à la taille L. Pour certaines étapes, demandez l'aide d'une ou deux personnes.*
- (NL) *Deze opbouwbeschrijving toont de montage van de terraskast Romeo, grootte M. Deze handleiding geldt ook voor grootte L. Voor enkele montage stappen heeft u 1 of 2 extra mensen nodig.*
- (ES) *Notas importantes para el montaje: Estas instrucciones de montaje muestran cómo montar el armario Romeo, tamaño „M“; pero esto también se aplica al tamaño „L“. Es recomendable realizar el montaje entre dos o tres personas.*
- (IT) *Indicazioni importanti per il montaggio! Il presente manuale mostra come assemblare l'armadio da esterno Romeo mis. M. Lo stesso si applica anche per l'assemblaggio della mis. L. Per alcune fasi di assemblaggio vi serviranno 1 - 2 aiutanti.*
- (DK) *Den medsendte montagevejledning viser samlingen af Terrasseskabet Romeo I str. "M", men er tilsvarende for str. "L" også. Ved flere punkter af opsætningen er yderligere hjælp påkrævet af 1 eller 2 personer.*

! Um Kratzer zu vermeiden, verwenden Sie bitte geeignete Unterlagen!

- (GB) *Please use a suitable underlay to avoid scratches!*
- (FR) *Pour éviter les rayures, utilisez les supports appropriés!*
- (NL) *Om krassen te voorkomen raden wij u aan er iets onder te leggen!*
- (ES) *Por favor, coloque en el suelo una base protectora adecuada para evitar posibles arañazos.*
- (IT) *Utilizzare una base adatta per evitare graffi!*
- (DK) *Benyt venligst et passende underlag for at undgå skrammer!*

! Schraubverbindungen grundsätzlich erst am Ende der Montage festziehen!

- (GB) *Nuts not to be tightened before the end of assembly!*
- (FR) *Ne serrer les écrous à fond qu'à la fin du montage!*
- (NL) *Schroeven pas aan het einde van de montage vastdraaien!*
- (ES) *En principio, no apriete fijamente las tuercas hasta que no haya terminado de montar la caseta.*
- (IT) *I dadi devono essere serrati a fondo soltanto alla fine del montaggio!*
- (DK) *Møtrikkerne må ikke strammes før slutningen af opsætningen!*

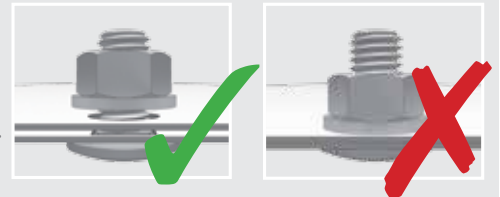

! Nicht bei Wind aufbauen!

- (GB) *Do not assemble the box on a windy day!*
- (FR) *Ne pas assembler quand il y a du vent !*
- (NL) *Niet opbouwen in de wind!*
- (ES) *!No montar con ráfagas de viento!*
- (IT) *Non costruire nel vento!*
- (DK) *Saml ikke skuret på en blæsende dag!*



! Verwenden Sie bei der Montage Arbeitshandschuhe!

- (GB) *Wear working gloves!*
- (FR) *Portez des gants de travail*
- (NL) *Handschoenen gebruiken!*
- (ES) *Utilice unos guantes de trabajo.*
- (IT) *Utilizzare guanti da lavoro*
- (DK) *Brug arbejdshandsker!*



! Wasserwaagen - Symbol:

Betreffendes Einbauteil mit der Wasserwaage ausrichten.

- (GB) *Symbol of spirit level: Align the respective parts by using the spirit level.*
- (FR) *Symbole niveau à bulle: Lorsque ce symbole apparaît, vous devez ajuster l'élément à l'aide d'un niveau à bulle.*
- (NL) *Waterpas - symbol: Bij montageschappen waar dit symbool bijstaat is het noodzakelijk het betreffende onderdeel waterpas in te bouwen.*
- (ES) *Símbolo del nivelador: Indica que se debe ajustar y centrar la pieza con la ayuda de un nivelador.*
- (IT) *Simbolo di livella a bolla d'aria: Allineare il componente in questione con l'ausilio di una livella a bolla d'aria.*
- (DK) *Symbol for vaterpas: Juster de respektive dele ved hjælp af vaterpas.*

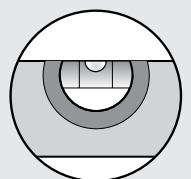



ACHTUNG: Im Sommer können im Innenraum sehr hohe Temperaturen entstehen!

- (GB) Attention: during the summer high temperature might arise in the interior.
- (FR) Attention: En été la température à l'intérieur de l'abri peut être élevée!
- (NL) Let op: in de zomer kunnen in de berging zeer hoge temperaturen bereikt worden.
- (ES) Tenga en cuenta que en el verano las temperaturas en el interior pueden ser altas.
- (IT) Attenzione: Si prega di prendere nota che in estate si possono essere temperature molto elevate all'interno.
- (DK) Vigtigt: Der kan opstå meget høje temperaturer i skuret om sommeren.

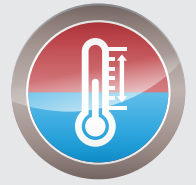

Pflege und Wartung

- Keine aggressiven Chemikalien wie z.B. Chlor oder Streusalz lagern!
- Sonnenmilch und andere Cremes mit Wasser und Seife entfernen
- Keine scheuernden Reinigungsmittel verwenden!
- Tiefe Kratzer sofort mit beiliegendem Lack ausbessern!
- Ölen Sie das Schloss jährlich!

(NL) Onderhoud

- Geen chemicaliën in de berging opslaan
- Zonnebrandolie/melk en andere cremes met water en zeep verwijderen
- Gebruik geen schuurmiddelen!
- Krassen direct met de meegeleverde lak behandelen
- Slot jaarlijks oliën

(DK) Pleje og vedligeholdelse

- Opbevar ikke aggressive stoffer dvs. Klor eller vejsalt!
- Fjern solcreme eller andre typer af creme med vand og rensmiddel!
- Brug ikke aggressive rengøringsmidler!
- Ved skrammer, brug straks malingen som er stillet til rådighed!
- Smør låsen årligt!

(EN) Care and maintenance

- Do not store aggressive substances i.e. chlorine or road salt
- Remove suntan lotion or any other creams with water and rinse aid!
- Do not use abrasive cleaning agents!
- Touch-up scratches immediately with the paint provided.
- Lubricate the lock once a year!

(ES) Cuidado y mantenimiento

- No almacene productos químicos agresivos dentro de la caseta como por ejemplo cloro y sal antiescarcha.
- Evite dejar huellas o restos de cremas solares sobre la chapa. Limpie la caseta siempre con agua o un trapo húmedo.
- Repare los arañazos lo antes posible con el barniz que se incluye
- Aplique aceite en la cerradura y las bisagras una vez al año

(FR) Entretien et maintenance

- Ne pas stocker de produits chimiques (chlore, sel, etc...)
- Nettoyez uniquement avec de l'eau les crèmes solaires et autres crèmes (pas de nettoyant chimique).
- Corrigez immédiatement les rayures avec la laque jointe!
- Graissez la serrure et les charnières chaque année !

(IT) Manutenzione

- Non lasciare prodotti chimici aggressivi (come ad esempio cloro o sale per strade) all'interno della casetta!
- Rimuovere crema solare e altre creme con acqua e brillantante!
- Ritoccare immediatamente eventuali graffi con la vernice fornita nella confezione!
- Lubrificare la serratura e le cerniere a cadenza annuale!

Maßstabsgetreue Abbildungen der zu verwendenden Schrauben:

- (GB) Scale drawing 1:1 of the screws in use
- (FR) Reproduction selon l'échelle 1:1.
- (NL) Afbeelding : schaal 1:1 (ware grootte)
- (ES) Reproducción a escala 1:1 de los tornillos que se utilizan para el montaje.
- (IT) Immagine in scala delle viti da utilizzare!
- (DK) Skala tegning af skruer er 1:1

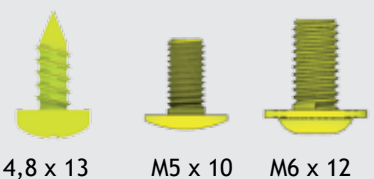

M 1:1



1 Paket Nr. 1
 Türpaket · Doorpackage · Carton de portes · Deurpakket · Kit de puerta · Pacco porta · Dørpakke

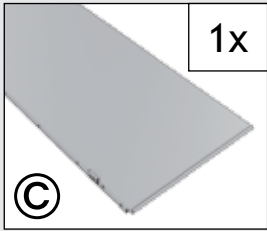
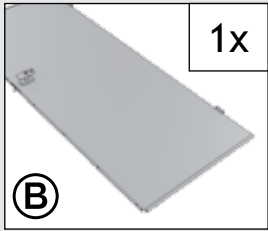

2 Paket Nr. 2
 Korpuspaket · Corpus package · Colis de l'ossature · Framepaket · Corpus · Corpus · Kassepakke

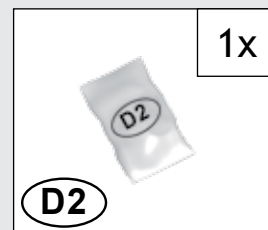
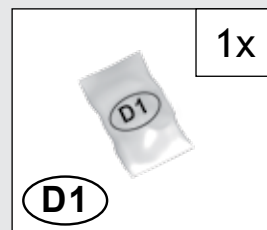
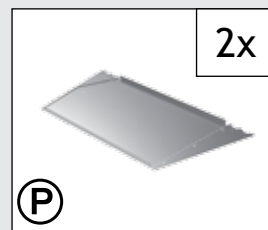
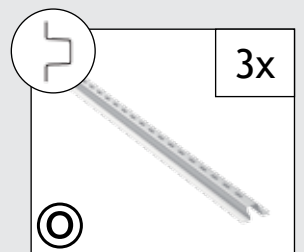
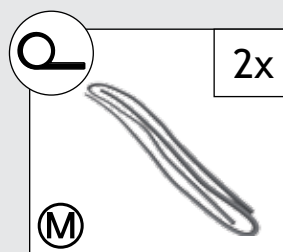
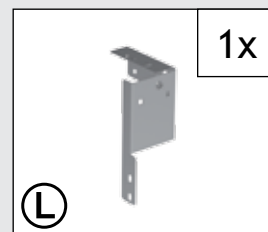
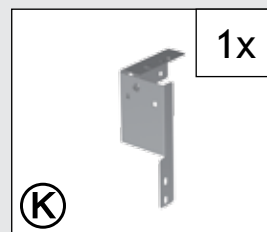
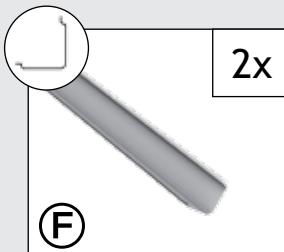
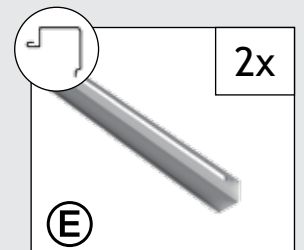
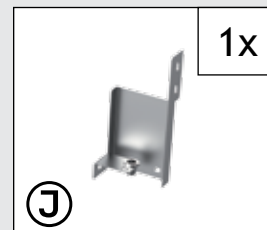
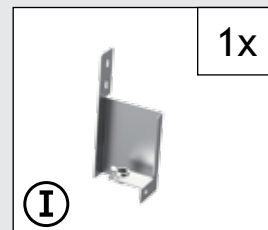
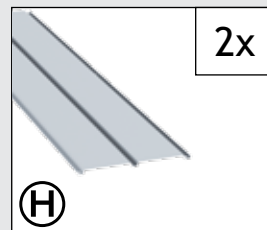
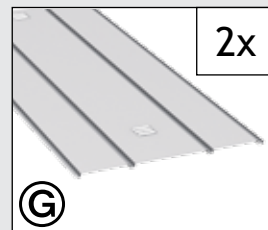



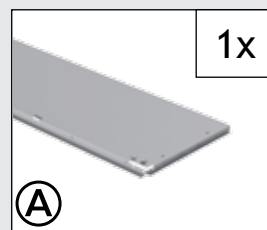
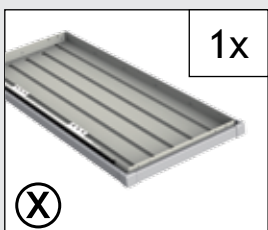

3 Paket Nr. 3
 Deckel-Bodenpaket · Lid/floor package · Carton de couvercle / Tôle de fond · Deksel / Bodem pakket · Paquete tapa/suelo · Pacchetto coperchio/pavimentazione · Låg / Gulvpakke

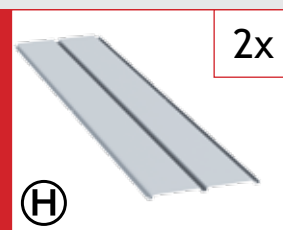

Nur für Größe L
 Only for size L
 Uniquement pour taille L
 Alleen voor maat L
 Sólo para los tamaños L
 Solo per misura L
 Kun for størrelse L

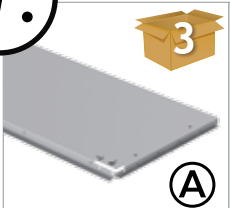

1.

 3 A	1x	 2 I	1x	 2 J	1x
 2 J	1x	M5 x 10  2	10x		



Festziehen

- GB tighten
- FR serrez fort
- NL vastdraaien
- ES apriete
- IT serrare a fondo
- DK fastspænding

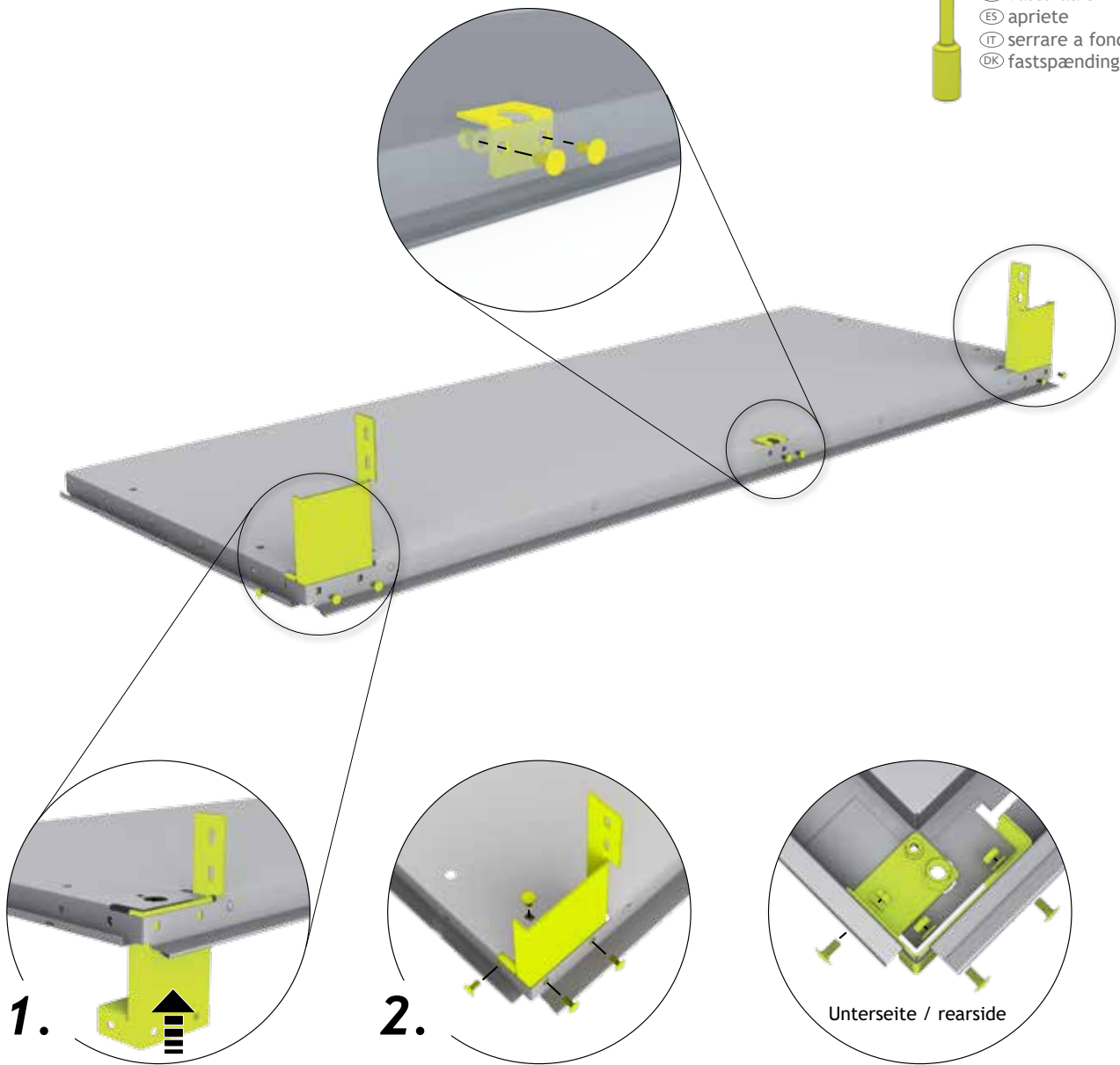

2.

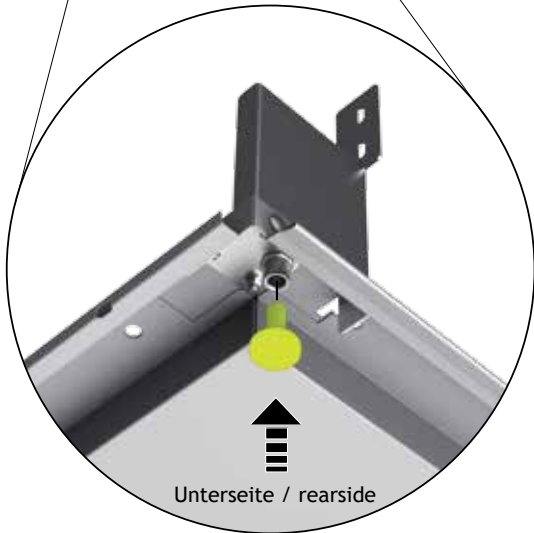
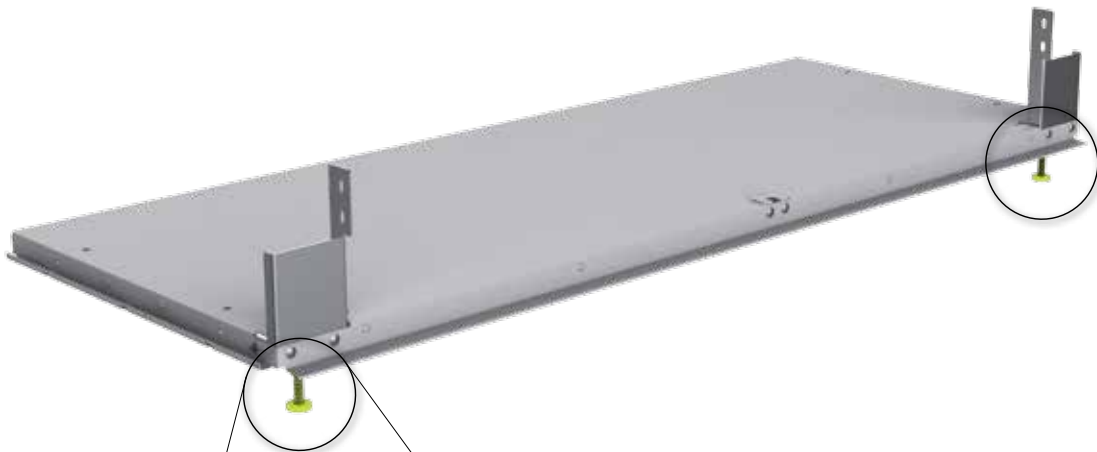
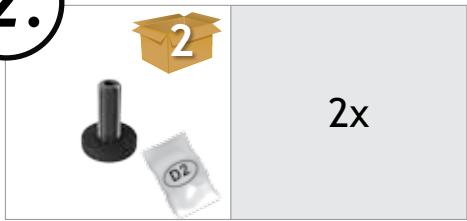

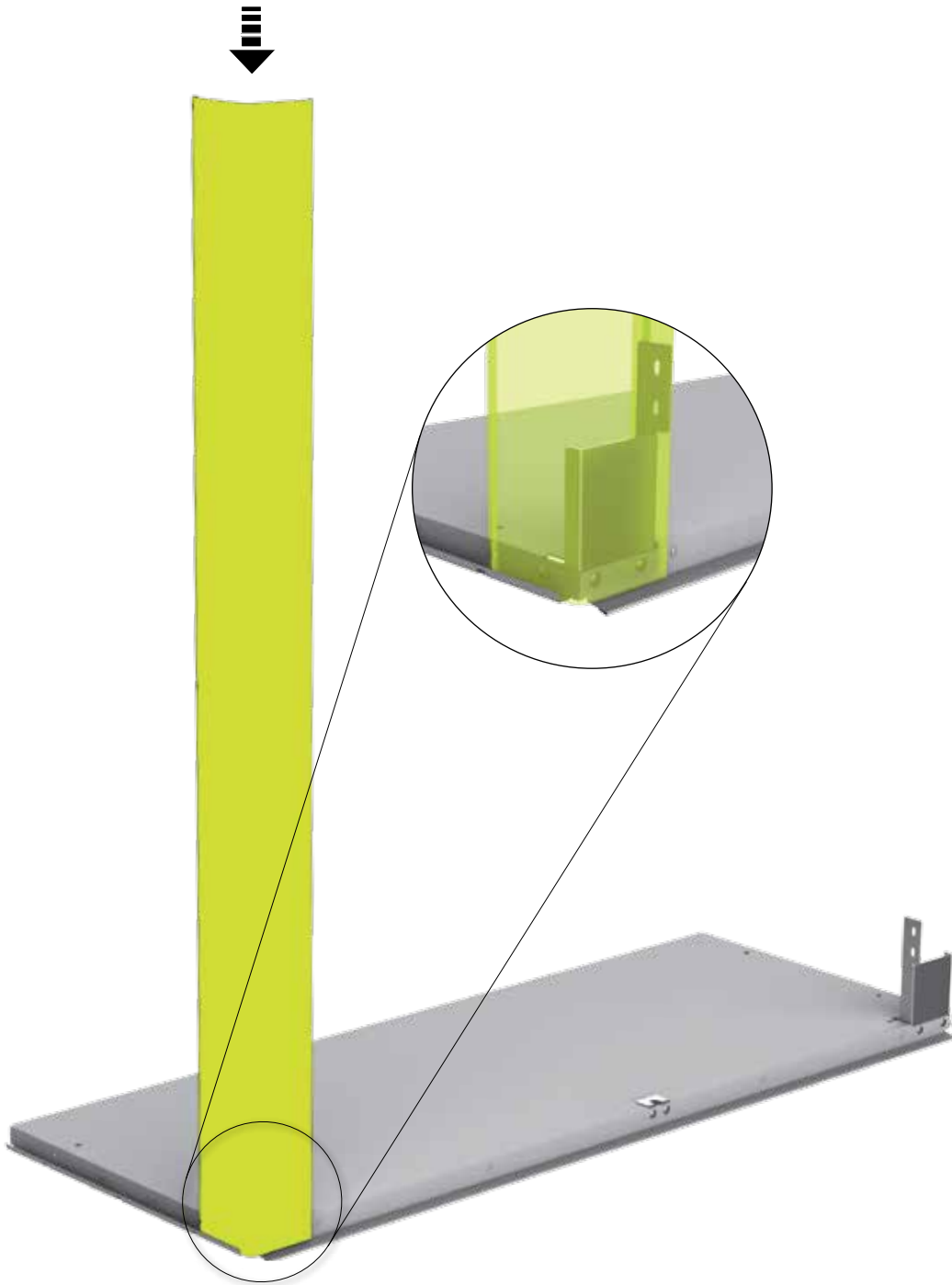
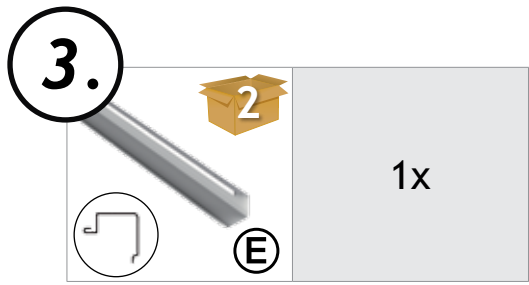

<p>4.</p>  <p>2/3</p> <p>Ⓜ</p>	<p>Romeo M: 1x Romeo L: 2x</p>	<p>4,8 x 13</p>  <p>2</p>	<p>Romeo M: 1x Romeo L: 2x</p>	<p>M5 x 10</p>  <p>2</p>	<p>Romeo M: 1x Romeo L: 2x</p>
---	------------------------------------	--	------------------------------------	---	------------------------------------

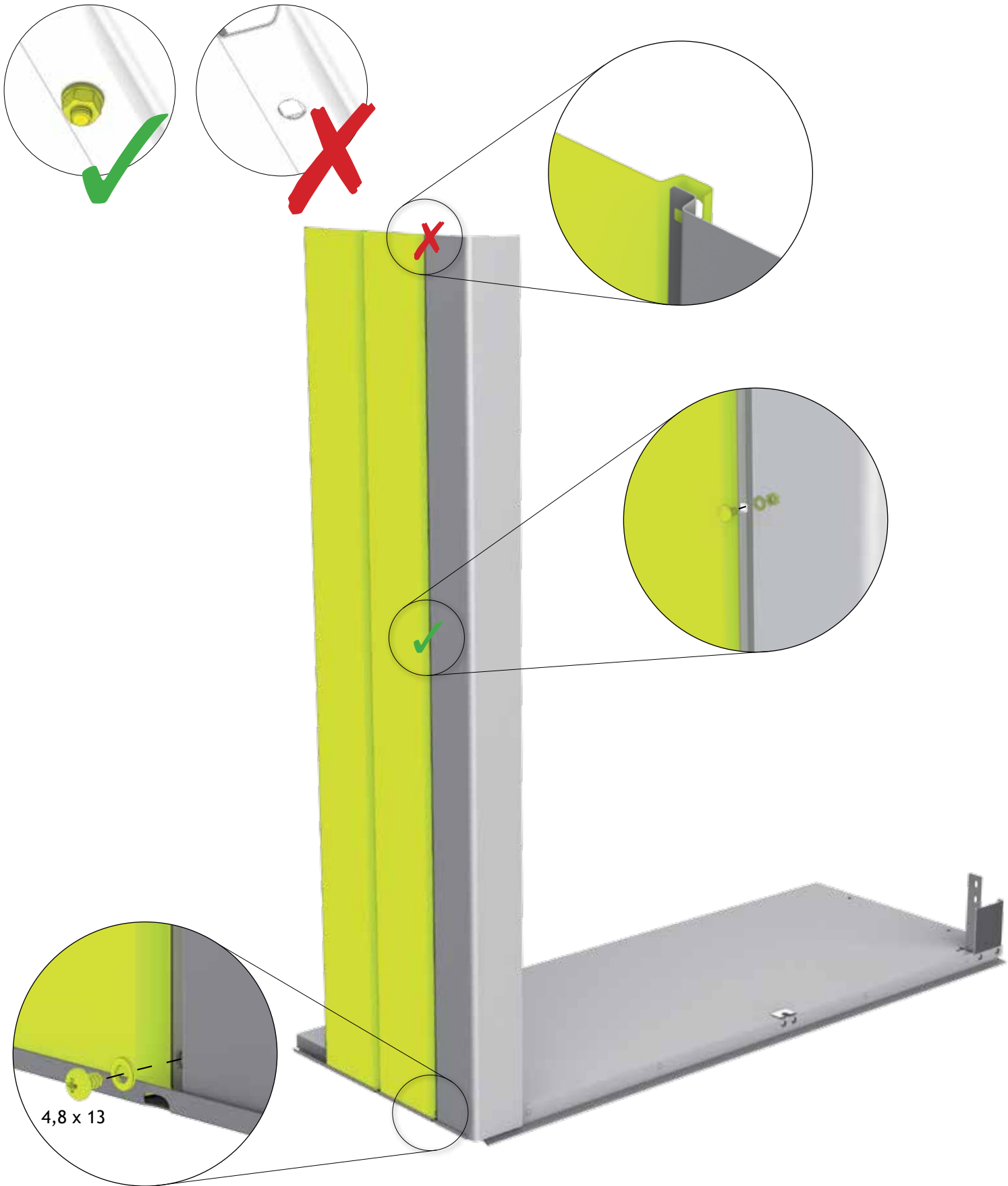



Nur für Größe L

Only for width L

Juste pour la largeur de L

Alleen voor breedte L

Sólo para el ancho de L

Solo per larghezza L

Kun for størrelse L

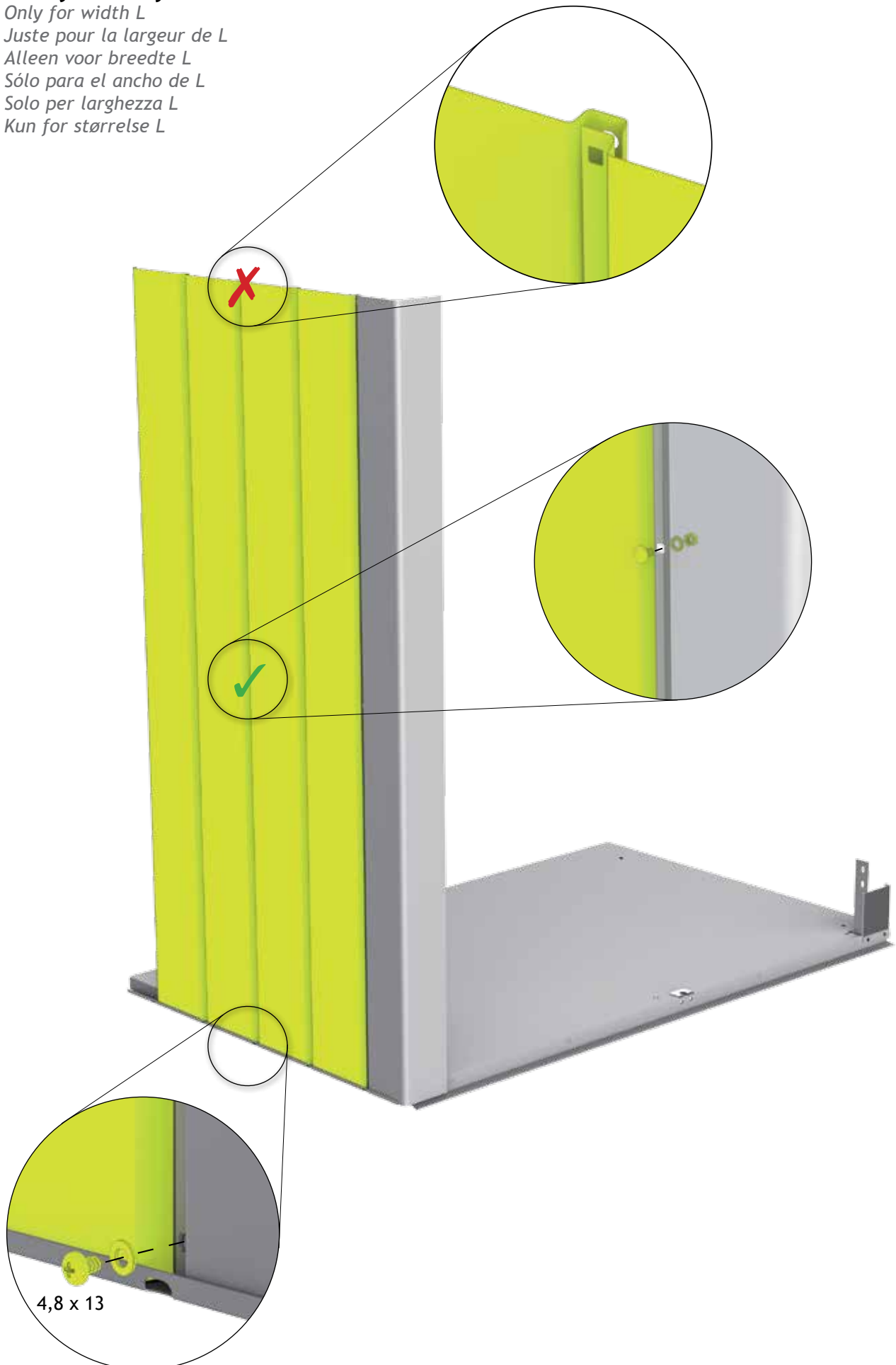

<p>5.</p> 	<p>1x</p>	<p>4,8 x 13</p> 	<p>1x</p>	<p>M5 x 10</p> 	<p>1x</p>
--	-----------	--	-----------	---	-----------

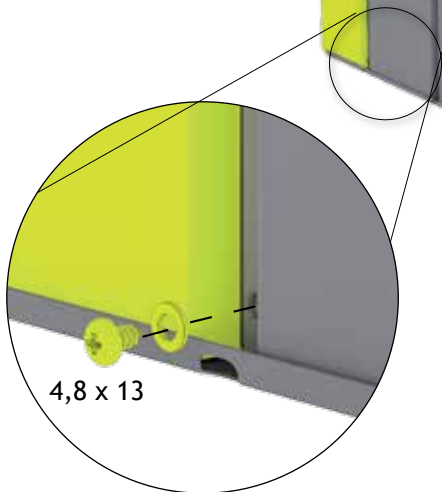
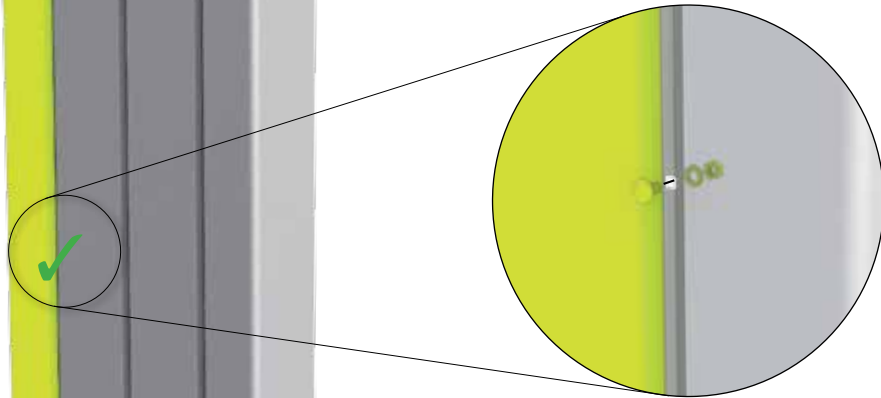
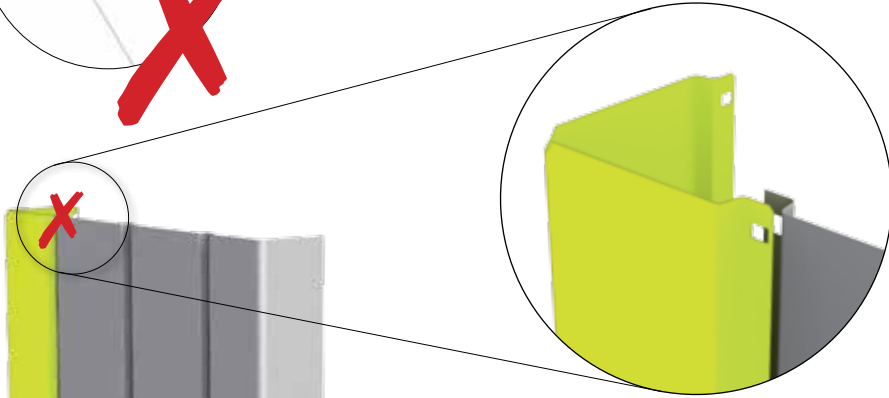
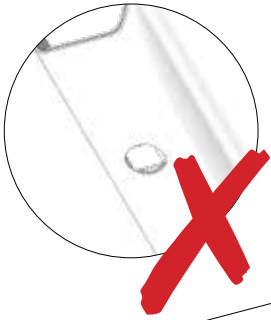
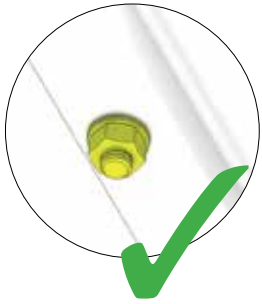

6.

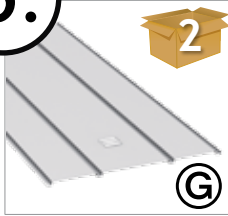

2x

4,8 x 13



2x



M5 x 10

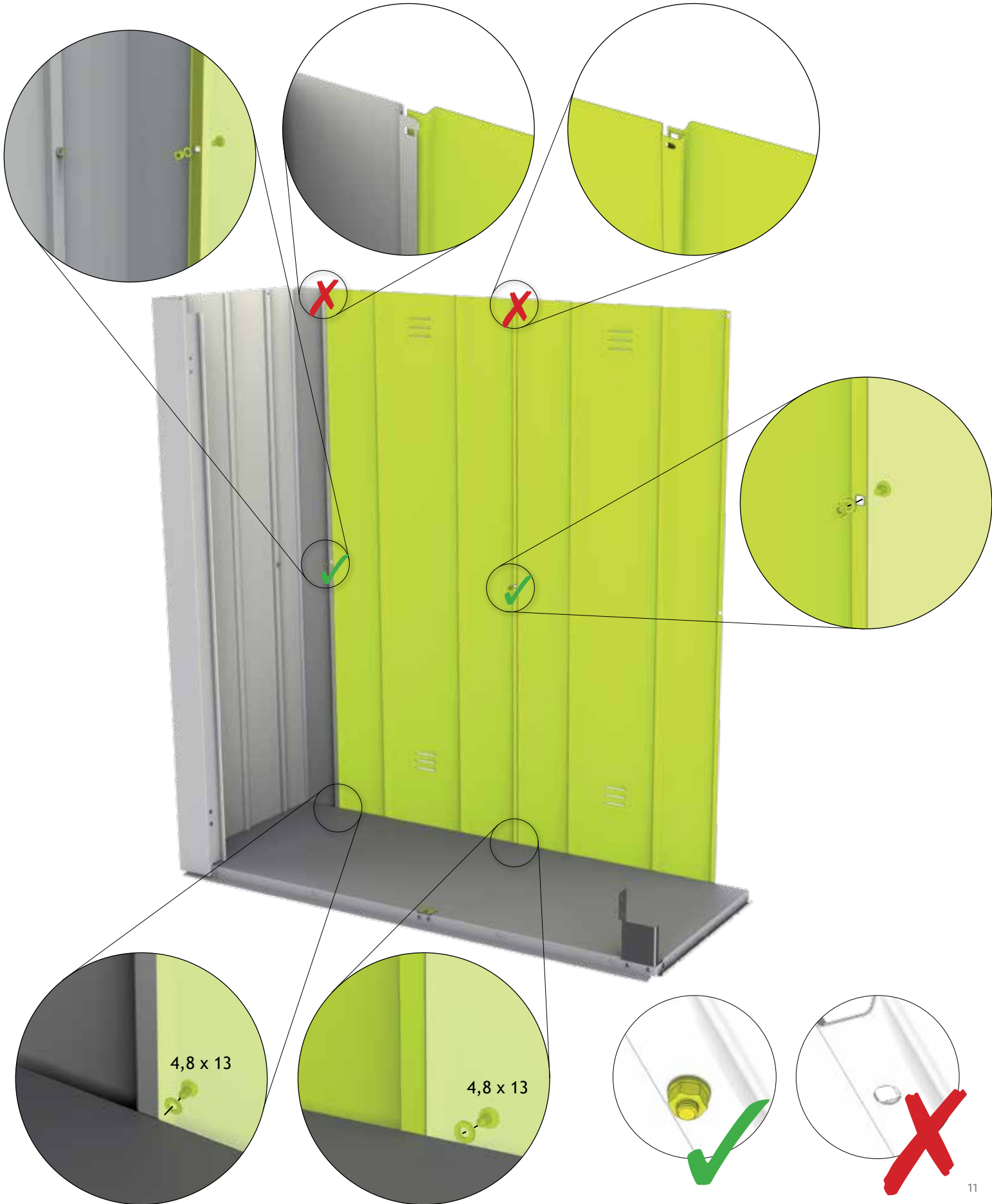

2x

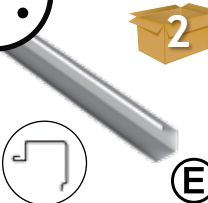
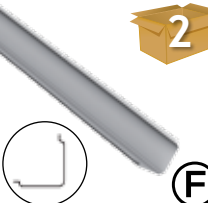
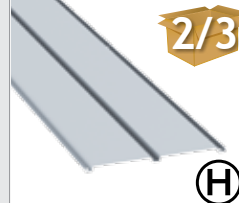

7.

 <p>2</p> <p>E</p>	<p>1x</p>	 <p>2</p> <p>F</p>	<p>1x</p>	 <p>2/3</p> <p>H</p>	<p>Romeo M: 1x Romeo L: 2x</p>
<p>4,8 x 13</p>  <p>2</p>	<p>Romeo M: 3x Romeo L: 4x</p>	<p>M5 x 10</p>  <p>2</p>	<p>Romeo M: 3x Romeo L: 4x</p>		

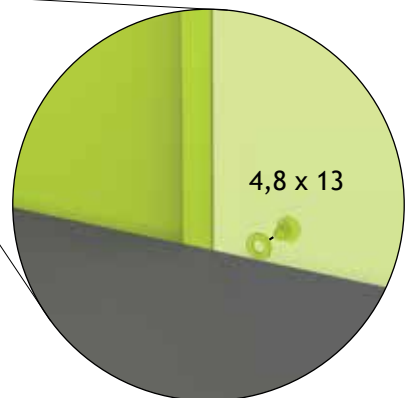
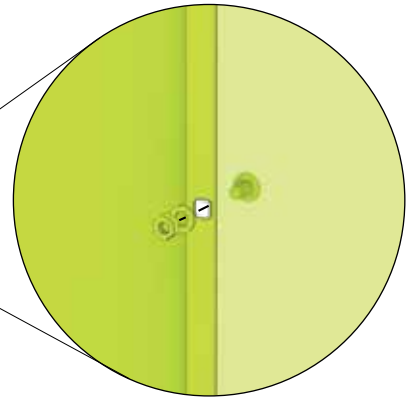
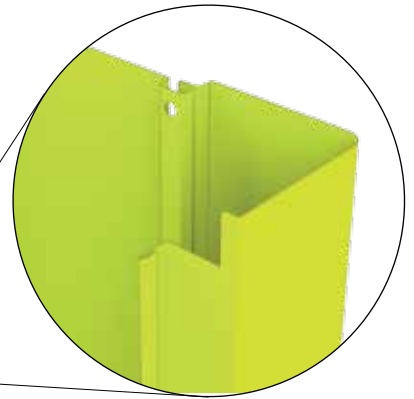
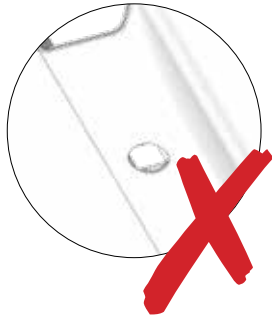
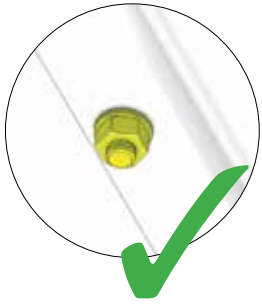





8.

2

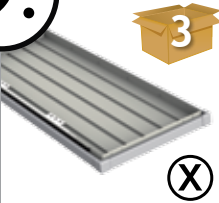
2x

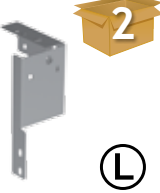

9.		1x		1x
		1x		
		8x		
				

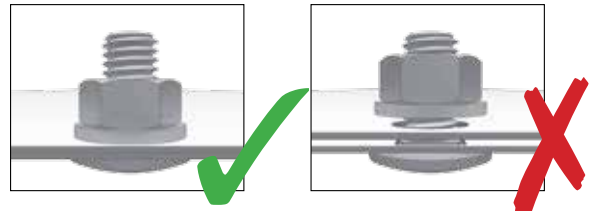

Alle in diesem Aufbausritt verwendeten Schrauben festziehen!
Tighten all screws needed in this work step!

M5 x 10

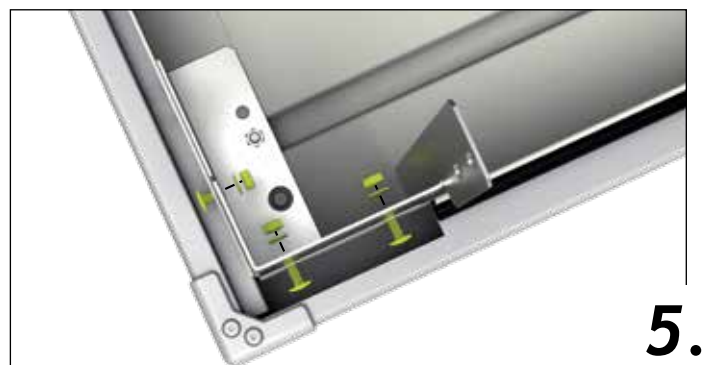
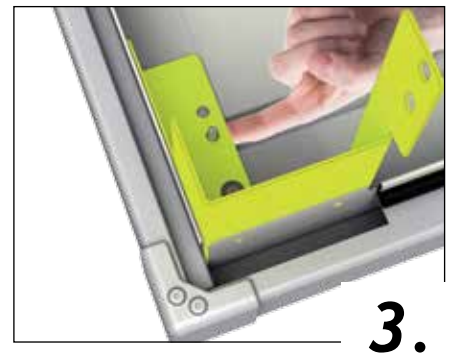
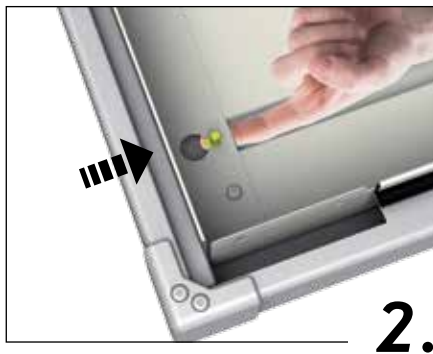
10.

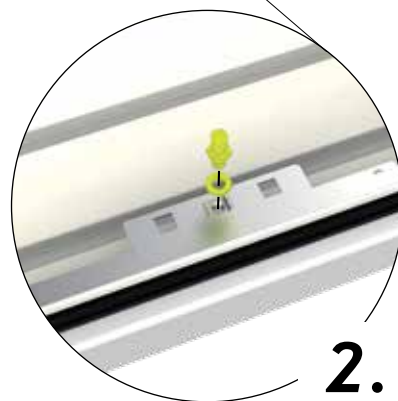
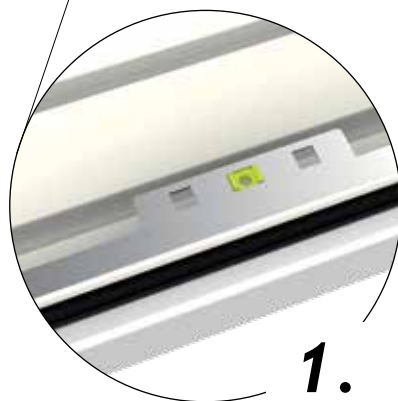
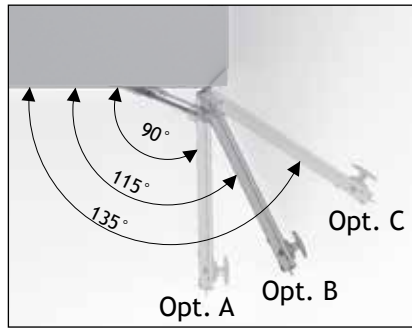
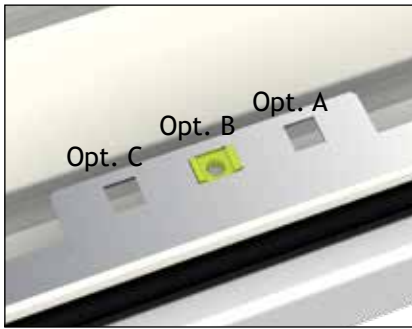

Festziehen

- Ⓒ tighten
- Ⓕ serrez fort
- Ⓖ vastdraaien
- Ⓔ apriete
- Ⓙ serrare a fondo
- Ⓚ fastspænding



11.



M5 x 10



M: 7x
L: 9x



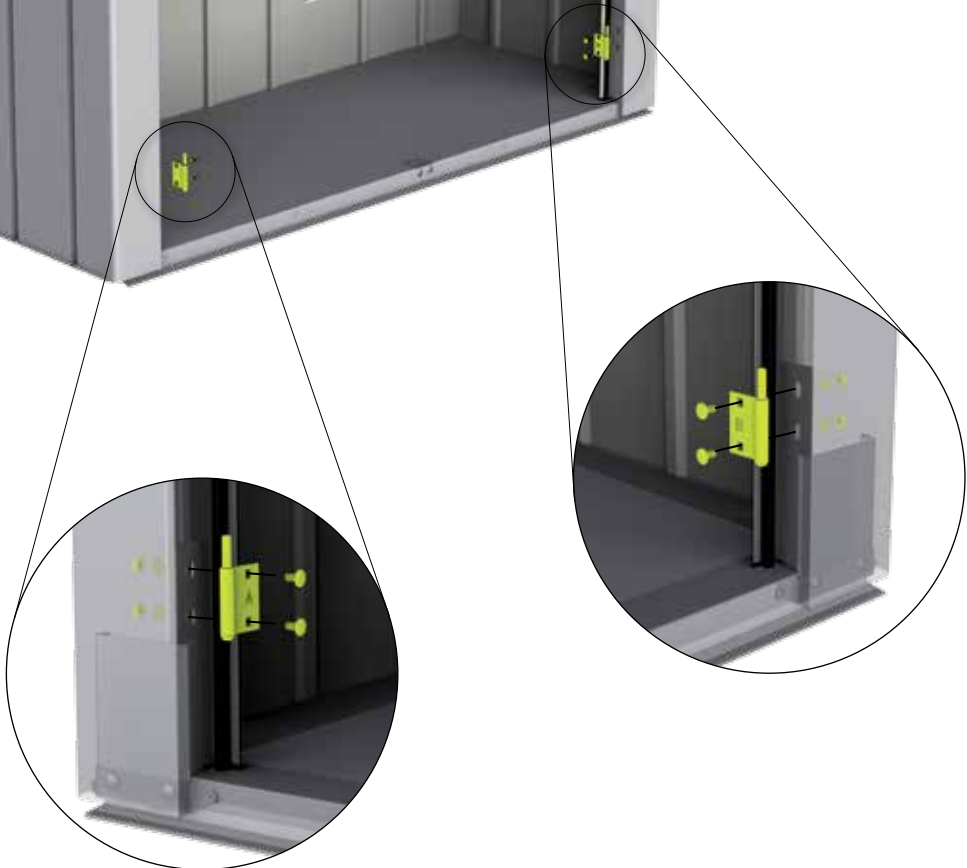

12.

	1x		1x	M5 x 10 	4x
---	----	--	----	---	----

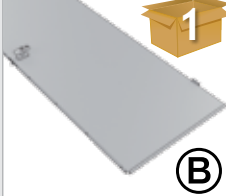
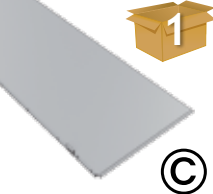

13.

 1x	 1x	 1x
 1x		

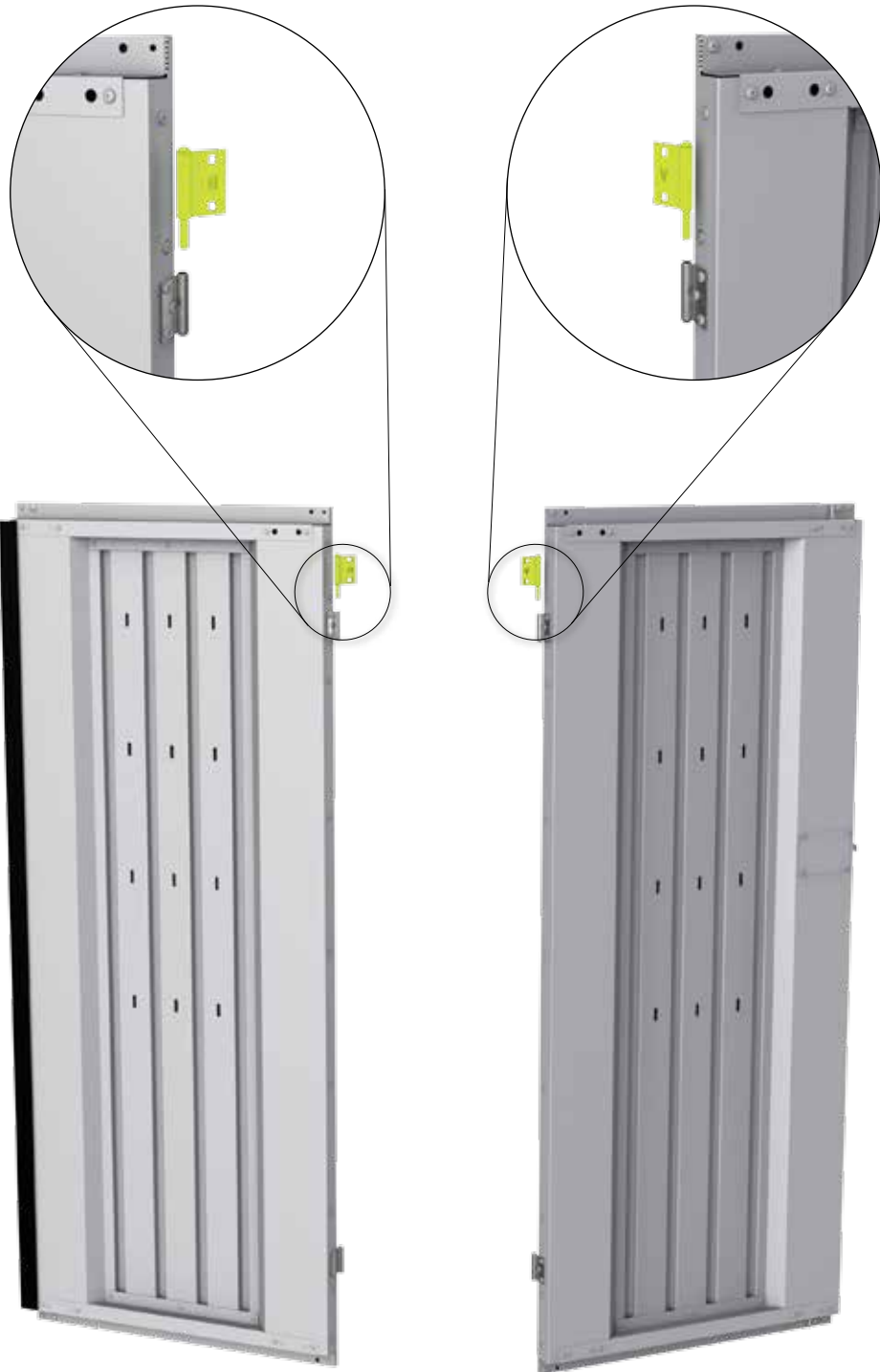



14.

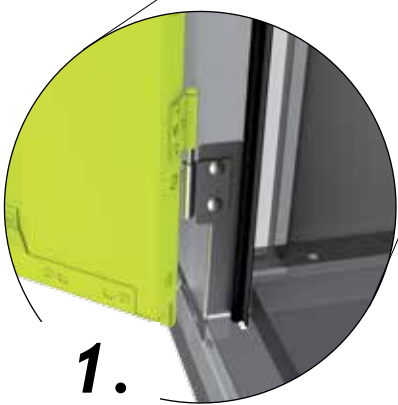



15.

	2x	M6 x 12		4x
---	----	---------	---	----



Festziehen
ⒸB tighten
ⒸR serrez fort
ⒸNL vastdraaien
ⒸES apriete
ⒸIT serrare a fondo
ⒸDK fastspænding



16.

2

2x





Ziehen Sie jetzt alle Schraubverbindungen fest an!

Tighten now all nuts and connections securely! - Serrez maintenant les vis à fond! - Draai nu alle schroeven vast! - Ahora puede apretar y fijar todos los tornillos y tuercas - Adesso serrare a fondo tutti i dadi - Fastspænd nu alle bolt-/skruerforbindelser!

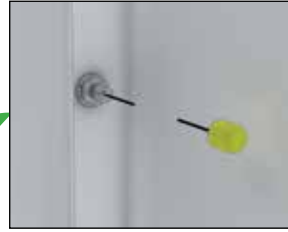
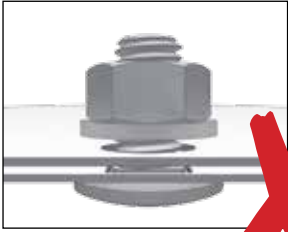

17.

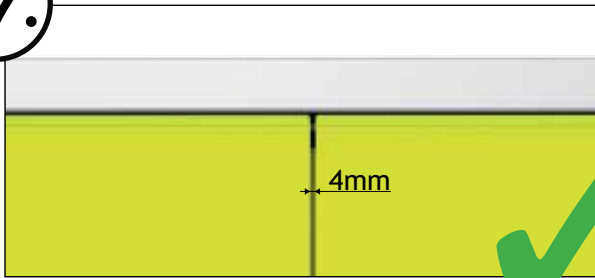

Tür einrichten



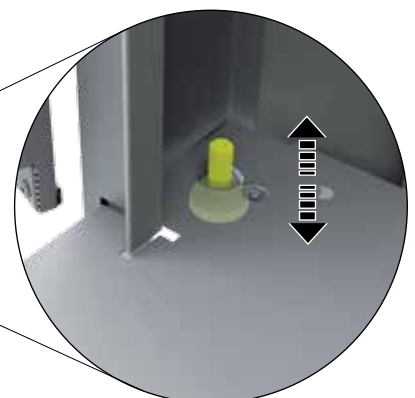
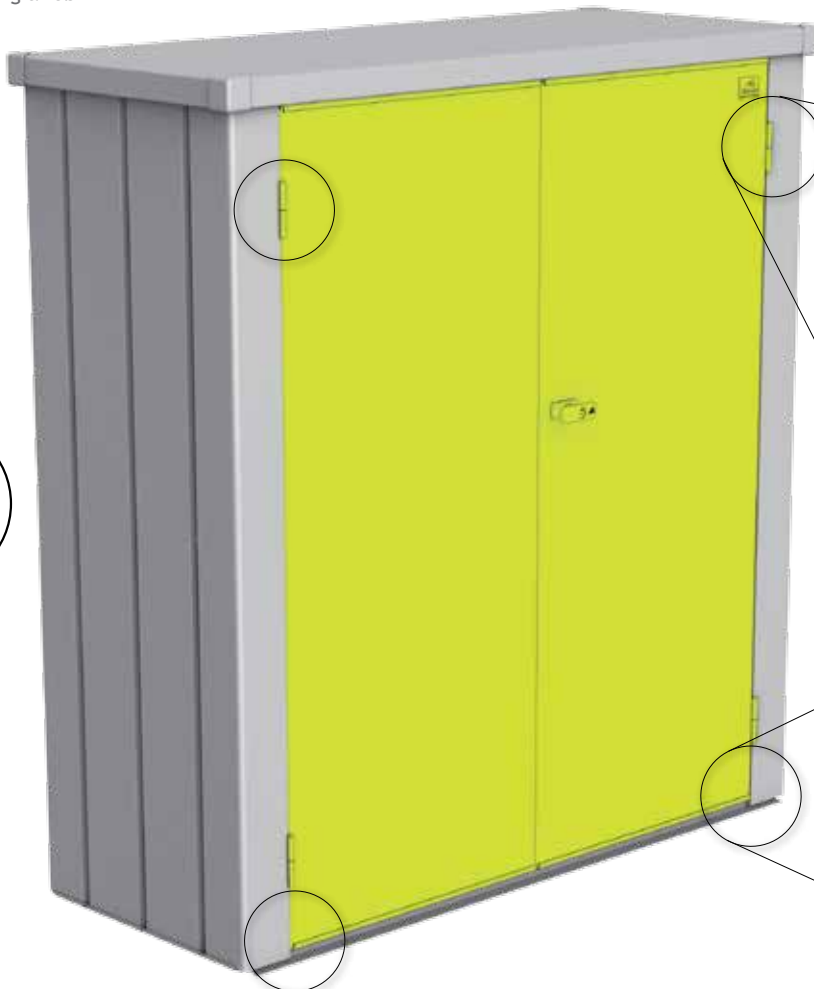
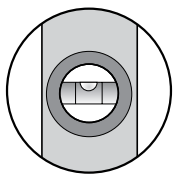
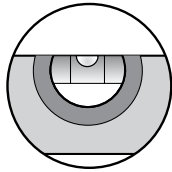



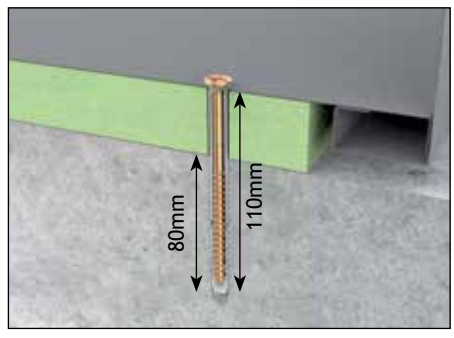
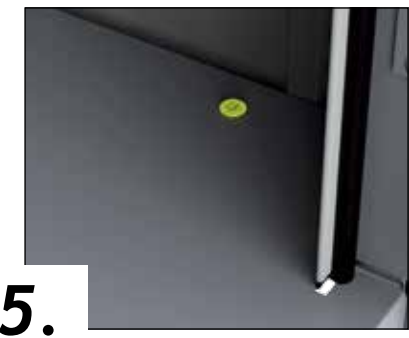
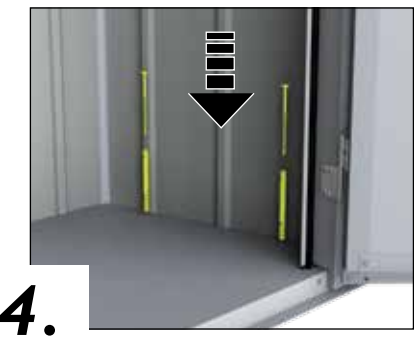
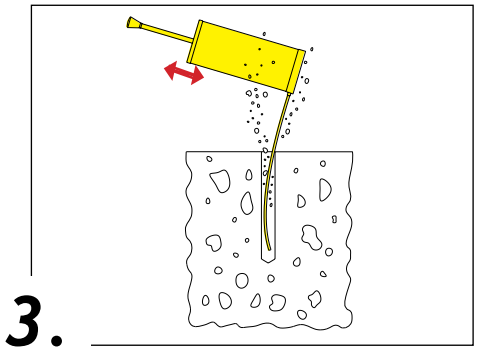
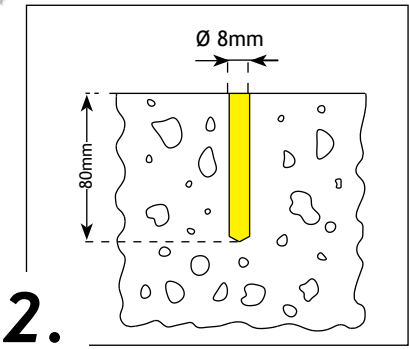
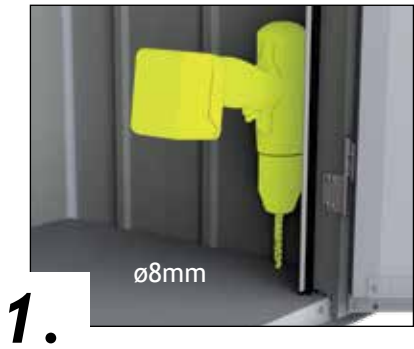
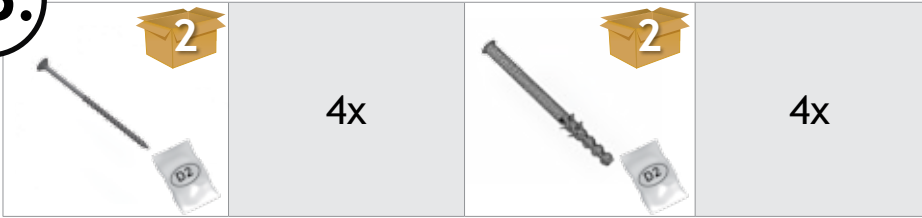



- Ⓒ align the door
- Ⓕ ajuster la porte
- Ⓓ deur afstellen
- Ⓔ ajuste la puerta
- Ⓙ aggiustare la porta
- Ⓖ justering af dør



18.



19

		3x		2x		4x
						

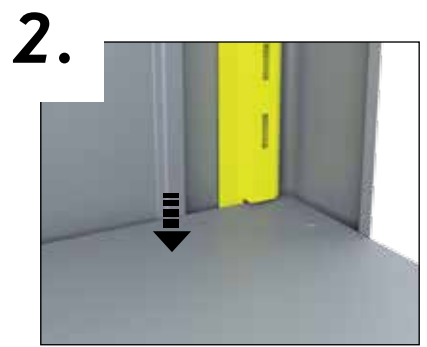
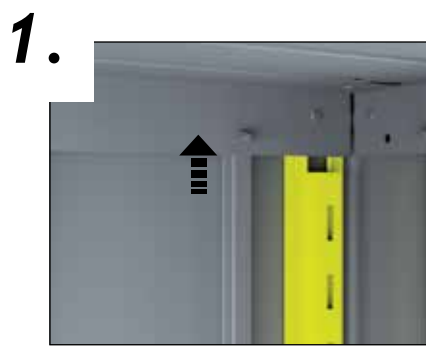
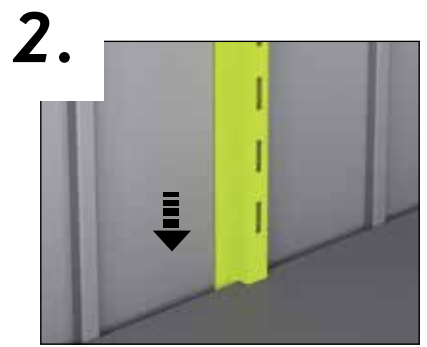
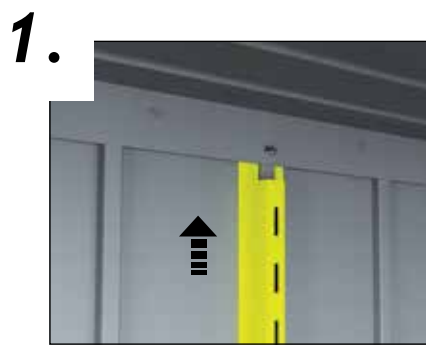

Option 1:

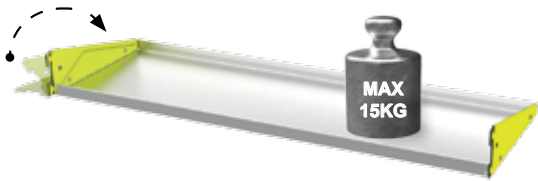

Option 2:

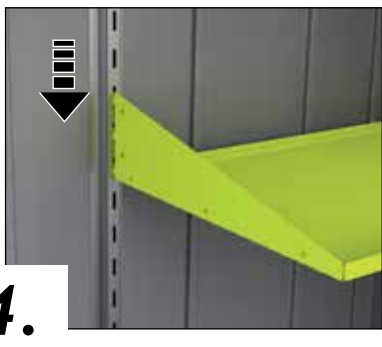

20.

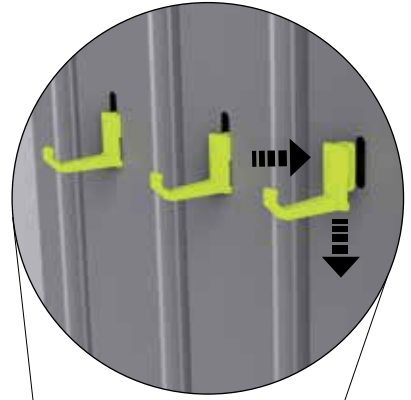



Gerätehäuser

Setzen Sie auf
Qualität & Langlebigkeit



Gartenboxen

Outdoorboxen für
Garten, Terrasse & Co



Fahrrad-Garagen

Fahrräder, Roller & Co sicher
verstaut



Mülltonnen-Boxen

Stylisch, praktisch
und wartungsfrei



Brennholzlager

Kaminholzlager und Geräte-
schrank in einem



Pflanzgefäße und Garten-Helfer

Gartendesign
in Bestform

Kontrollnummer:
Control-number / Contrôle-Qualité / Controlnummer:



Bei Reklamationen bitte anführen:
Kontrollnummer und Artikelnummer des reklamierten Teils.

GB: In case of complaint please indicate the control-number and the number of the item, which is subject of complaint.

F: Pour toutes réclamations: prière de joindre le numéro de contrôle et le numéro d'article de la pièce litigieuse.

NL: Bij reclamaties svp doorgeven: controlnummer en artikelnummer van het desbetreffende onderdeel.